

## Milling cutter holding block Milling sha

### Technical data

Drive

not live

Mounting

Milling shaft D16

X [mm]

–

Y [mm]

–

Z [mm]

–

**INDEX TRAUB products**

A100 • C42/65 • G160 • G300 •  
G400 • MS32C • MS52C • TNX80  
• V100 • V200 • A200-6 • ABC  
• B400 • C100 • C200 • G200 •  
G200.2 • G220 • G250 • MS16-6  
• MS22-6 • MS22-8 • MS32-6.2 •  
MS40-6 • MS40-8 • TNX65/42 •  
V160C • V160G • V300 • TNA400.2  
• ABC.2 • G300.2 • G320.2 • B400.3  
• TNA400.3

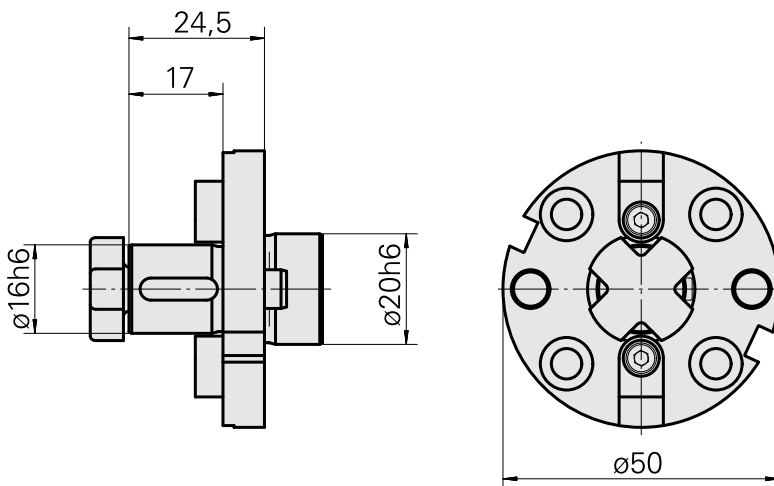
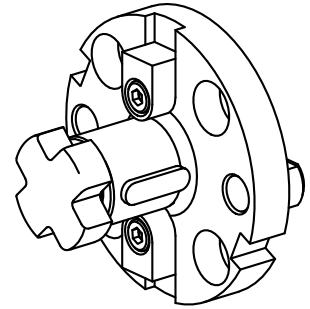

---

## Documents

No downloads available for this product

## Accessories

Required for operation

### [mill arbor wrench](#)

Product ID : 10007866

Previous product ID : 203020.1160

TH accessories  
category  
Tool

Mounting  
Milling shaft D16

Tools for Collet chucks  
Mill arbor wrench

### Optional accessories

#### Tool holder accessories

### [Screw](#)

Product ID : 10381768

Previous product ID : 250122.0820

TH accessories  
category  
Cutter tightening screw

Mounting  
M8

#### Other accessories

### [Ring](#)

Product ID : 10398855

Previous product ID : 251390.----

---

### [Ring](#)

Product ID : 10169490

Previous product ID : 251391.----

---