

## Clamping collet 145E/F25 Ø=10,00

### Technical data

Clamping device size	145E/F25
manufacturer product line	
Clamping type	grooved
Nominal diameter (mm)	10 Millimeter
Clamping method	External clamping
Collet version	Slots vulcanized (standard)
manufacturer product line	Schlenker

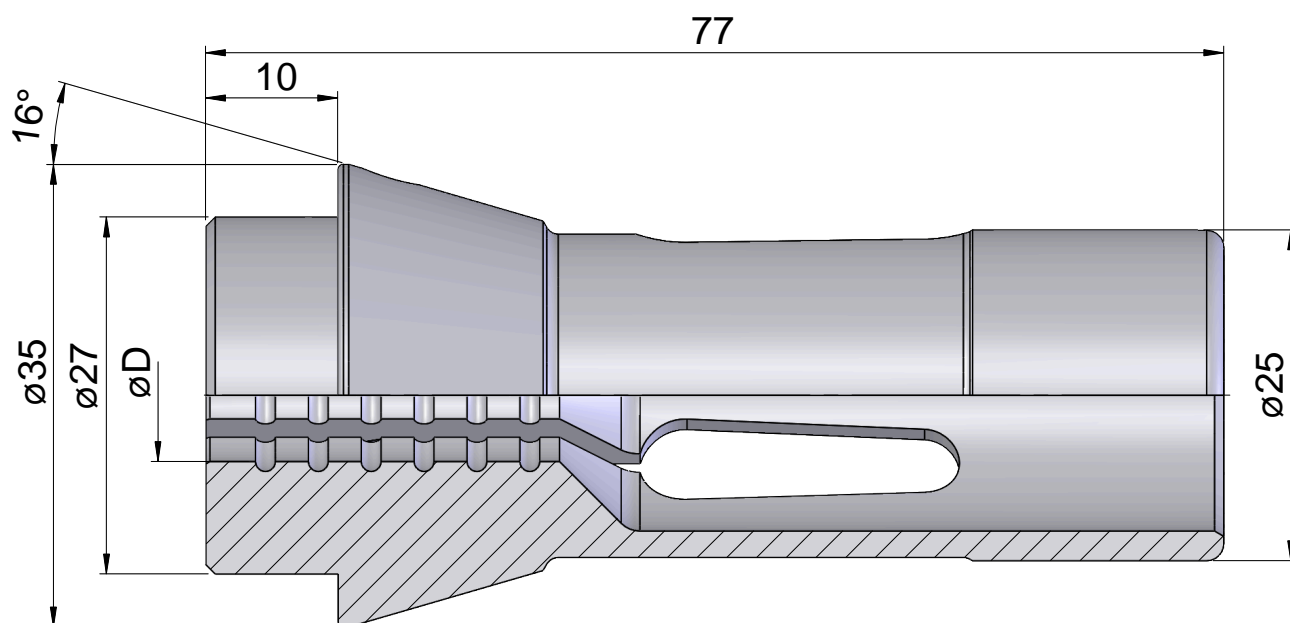

## **Documents**

No downloads available for this product