

Ring-Fraesdorn D10, Breite 3 mm

Technische Daten

WZH Zubehöorkategorie

Fräsdornring

Aufnahme

Fräswelle D10

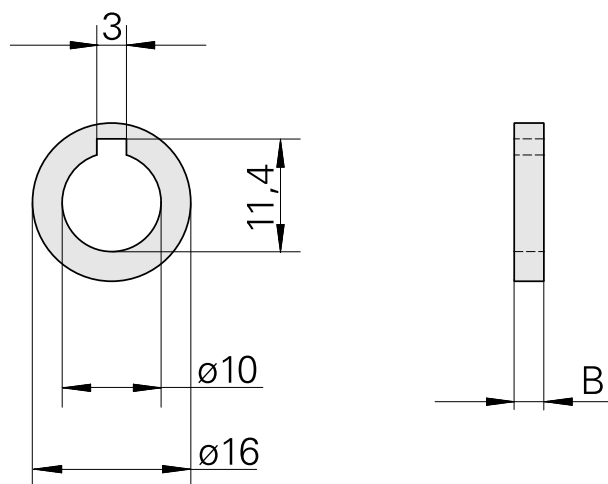

Dokumente

Für dieses Produkt sind keine Downloads vorhanden