

Boring head for DN.. 1506..

Technical data

Mounting	for DN.. 1506..
Cooling	internal
Pressure	50 bar
X [mm]	45 (1.77")
Z [mm]	22 (0.87)
INDEX TRAUB products	G220.3 • G220 • R200 • TNX65/42 • TNX220.3

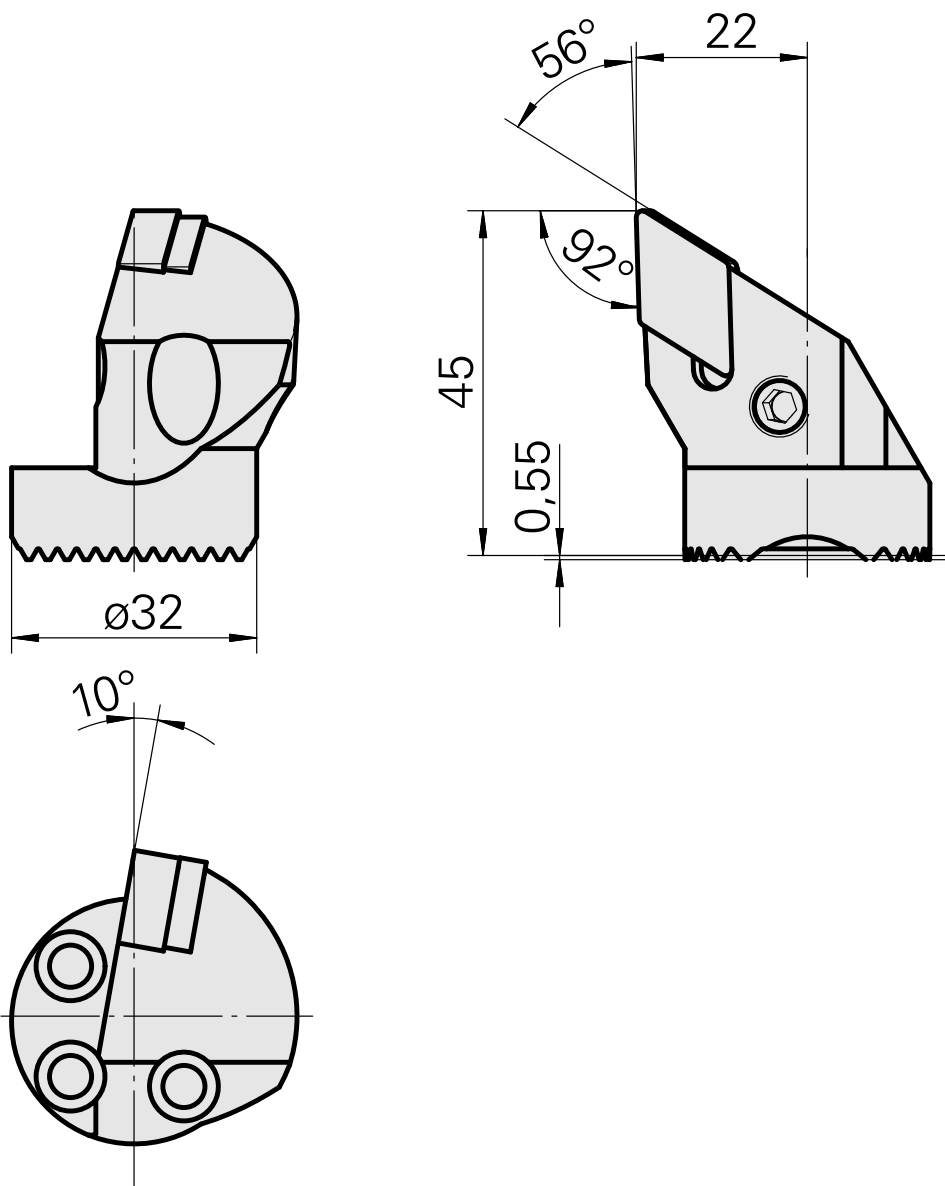

10684981
W9990283

INDEX

Documents

No downloads available for this product

Accessories

Required for operation

[Chucking parts 315004](#)

Product ID : 10023015

Previous product ID : W00014.0022
