

## Drilling tool holder VDI 30 MK3

### Technical data

Shank VDI	VDI 30
Drive	not live
Fixation VDI	none
Cooling	external
Pressure	20 bar
Mounting	MK3
reversible 180°	no
Data carrier	check tool station bore
X [mm]	45 (1.77")
Y [mm]	-
Z [mm]	-
INDEX TRAUB products	IT600 • V100 • V200 • V160C • V160G • V300 • TNA300

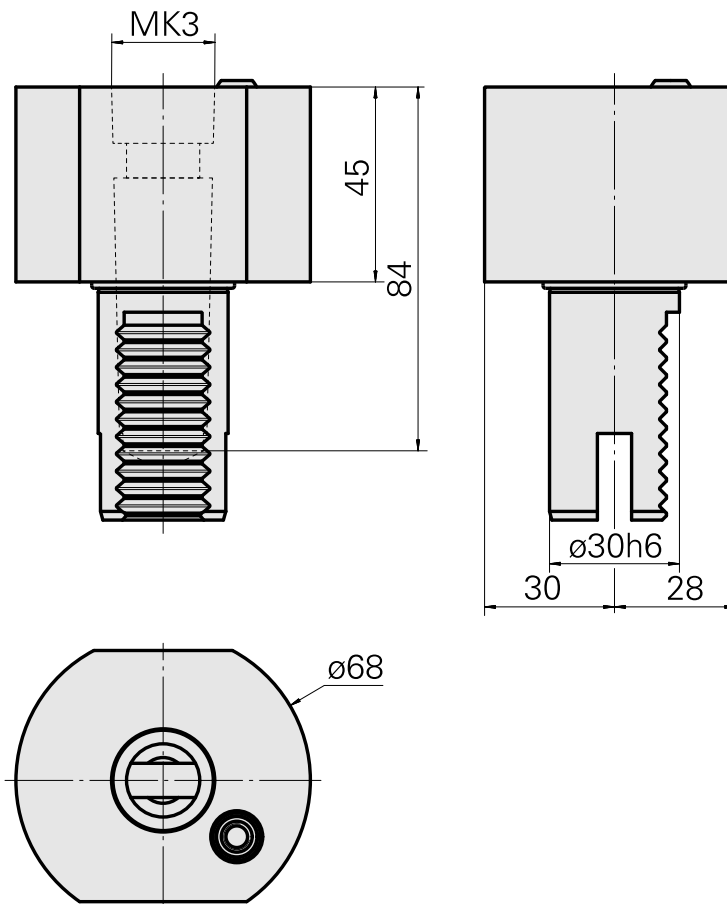
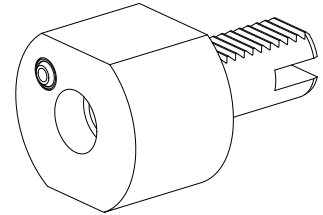

## **Documents**

No downloads available for this product