

## Grooving tool holding block, vertically adjustable

### Technical data

Drive

not live

Cooling

external

Pressure

20 bar

X [mm]

30 (1.18")

Y [mm]

–

Z [mm]

–

INDEX TRAUB products

A100 • C42/65 • G160 • ABC • C100  
• C200 • G200 • G200.2 • G220 •  
G250 • ABC.2

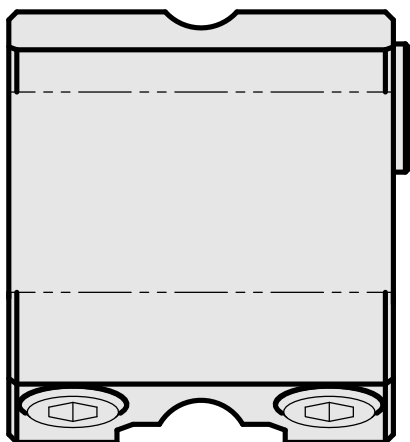
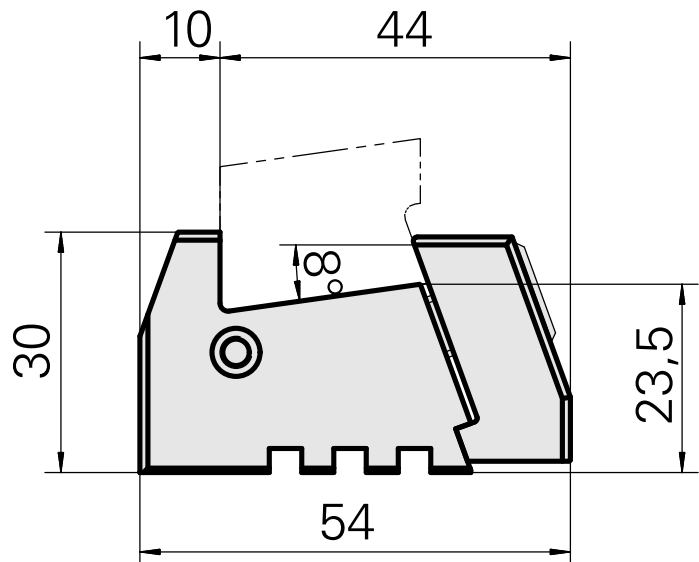
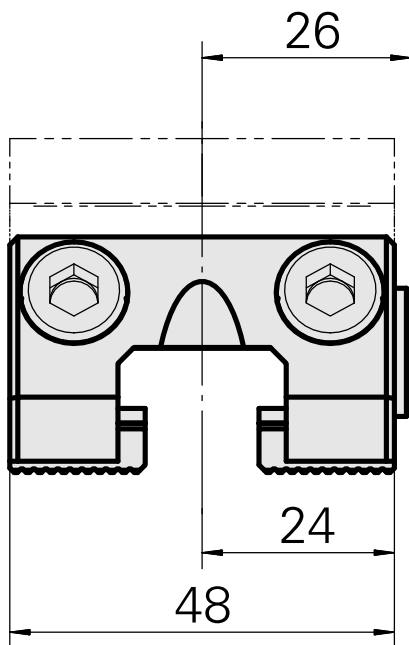
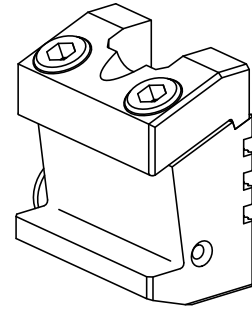

## **Documents**

No downloads available for this product

## **Accessories**

Optional accessories

**Other accessories**

[Shim](#)

Product ID : 10137275

Previous product ID : W31400.46

---