

Spannzange 1212E/F16 Ø=4,00

Technische Daten

Spannmittelbaugröße	1212E/F16
Hersteller Produktlinie	Spannzange
Spannausführung	glatt
Nenn Durchmesser	4 Millimeter
Spannmethode	Außenspannung
Spannzangenvariante	Schlitze vulkanisiert (Stdrd)
Hersteller Produktlinie	Schlenker

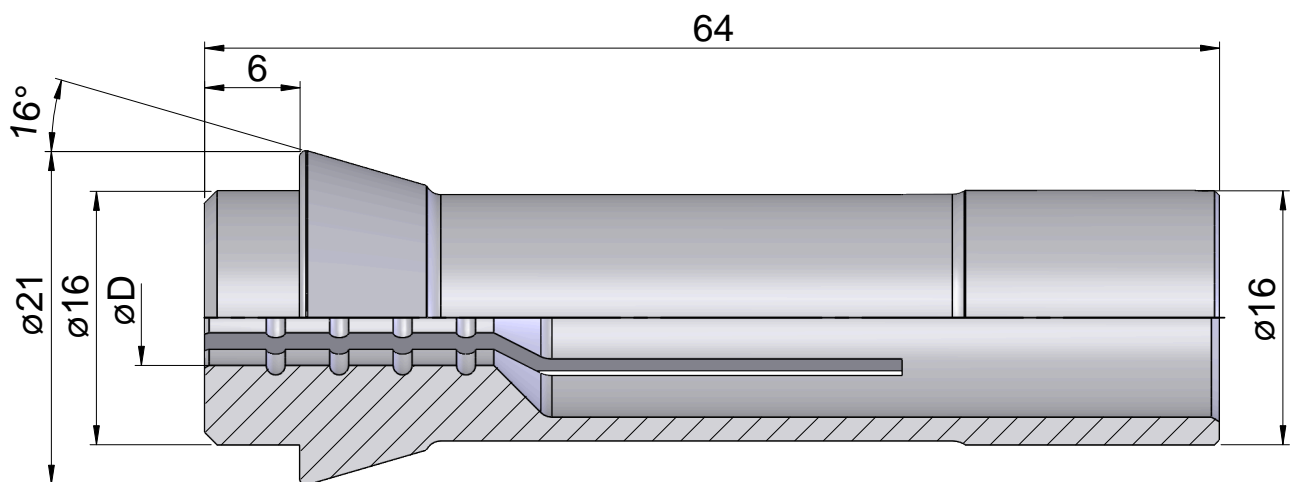

Dokumente

Für dieses Produkt sind keine Downloads vorhanden