

Saw blade, circular saw blade width 5 mm (0.19")

Technical data

TH accessories category

Circular saw blade d125

Tool mounting

22mm

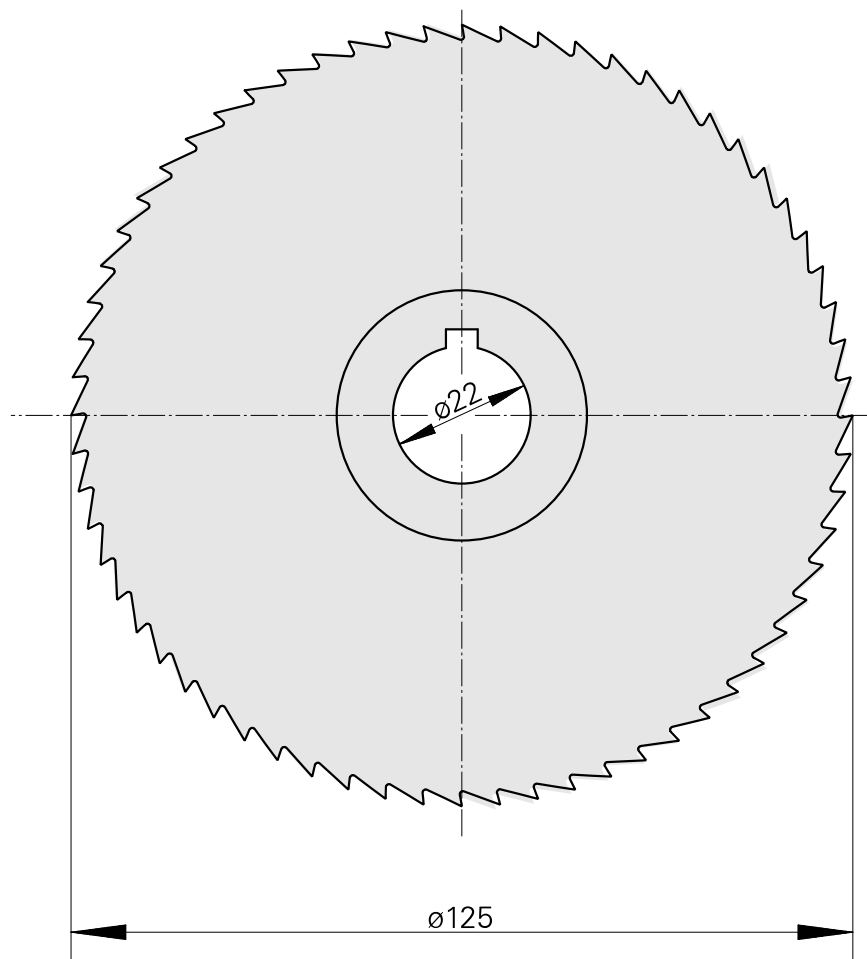

10474107
223015.2550

INDEX

Documents

No downloads available for this product