

适配器组装辅助 套筒 D36

技术特点

刀座附件类别
刀具夹具

适配器组装辅助
套筒 D36

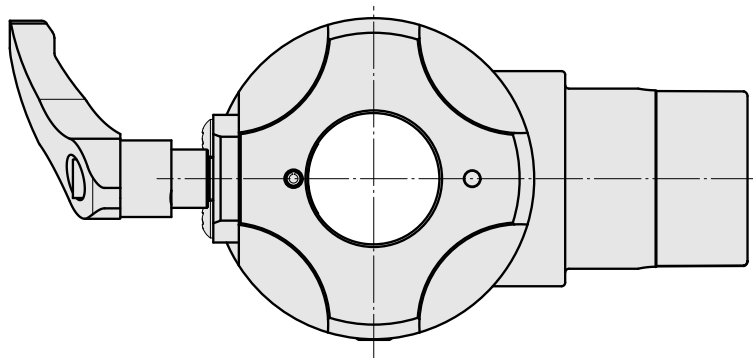
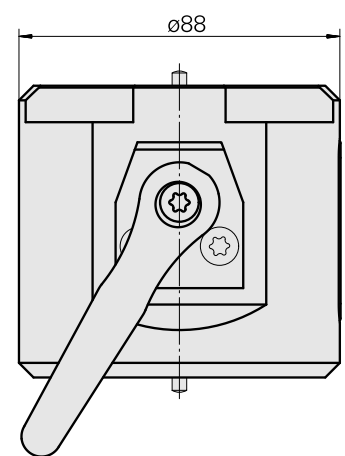
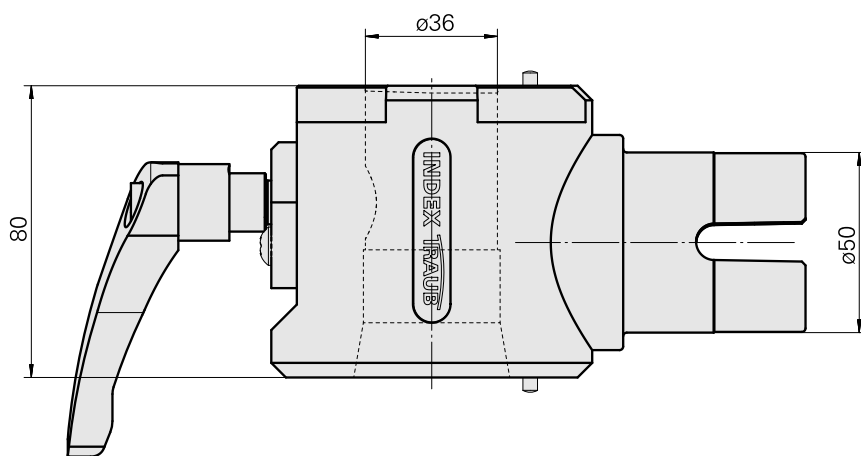
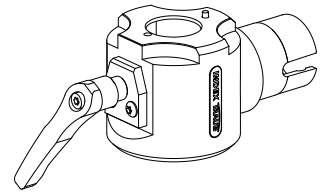

文件

没有针对此产品的任何下载