

## Adapter mounting aid INDEX CAPTO C6

### Technical data

TH accessories category

Adapter mounting aid

Tool mounting

CAPTO C6

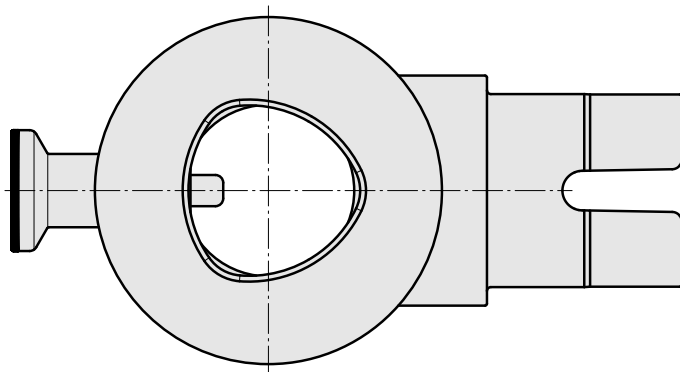
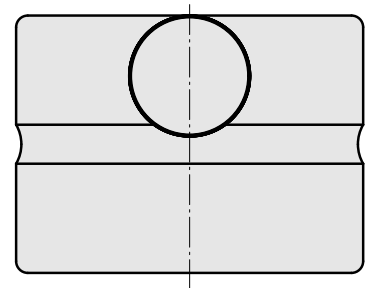

## **Documents**

No downloads available for this product