

## Adaptor ER16

### Technical data

There are currently no additional technical features stored for this product

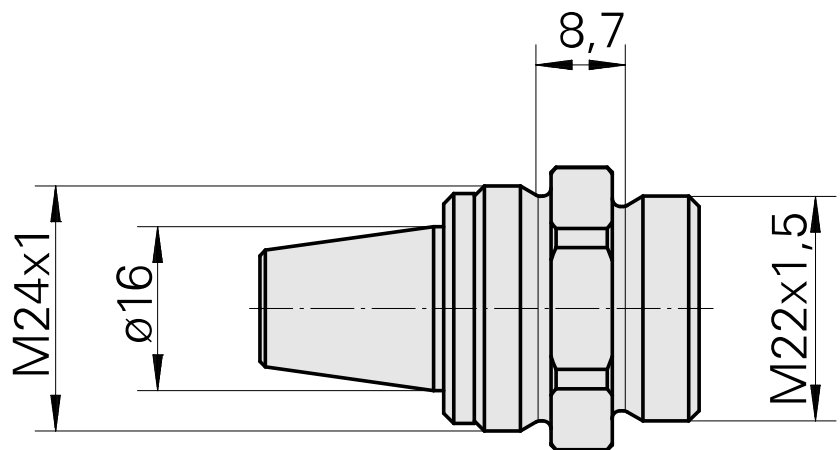
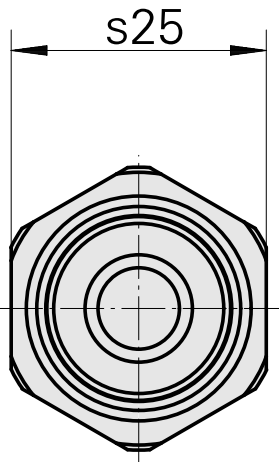
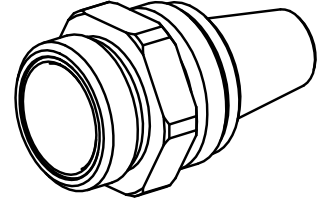

## **Documents**

No downloads available for this product