

钻头刀架 液压膨胀刀柄 D8

技术特点

驱动装置	非动力式
固定装置MS	锁紧环 D36
冷却	内冷
压力	80 bar
夹具	液压膨胀刀柄 D8
X [mm]	-
Y [mm]	-
Z [mm]	-
INDEX TRAUB产品	MS32-6.2 • MS40-6 • MS40-8 • MS32C • MS32-6.3

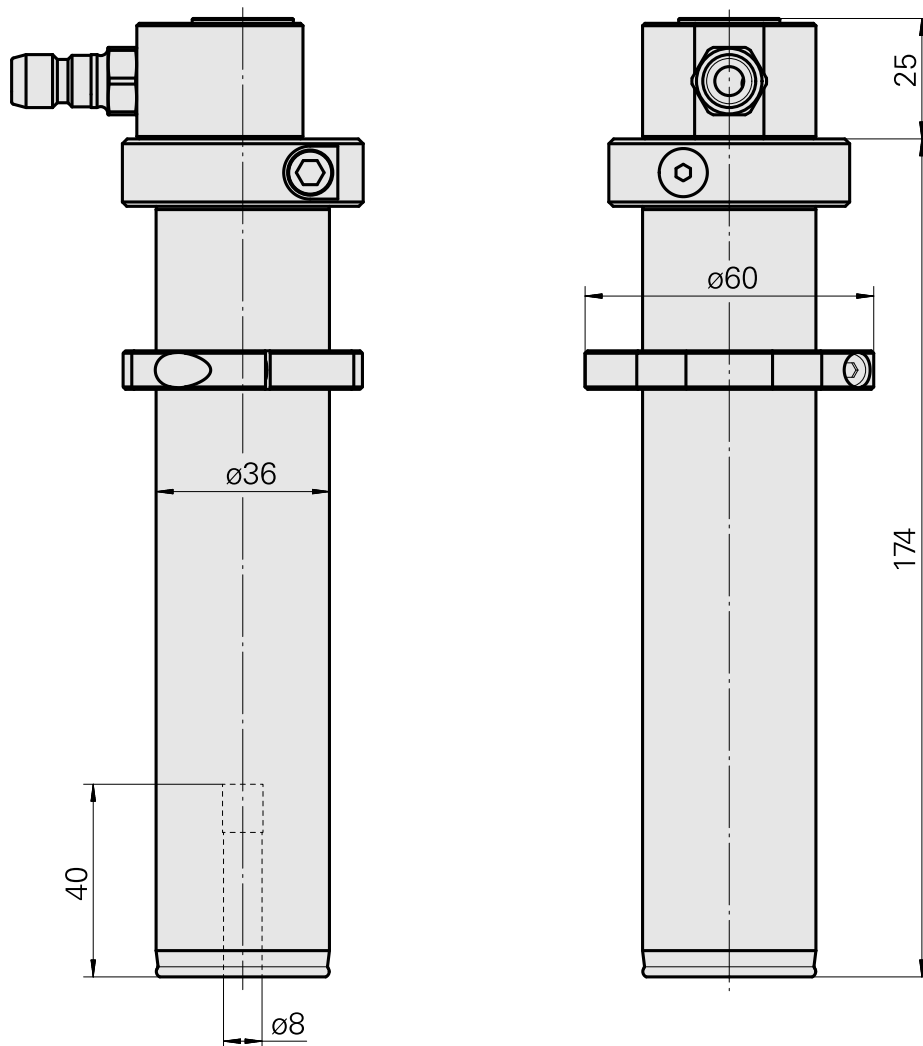
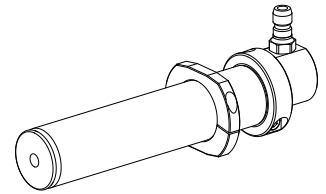

文件

产品提示

[DE \(pdf\)](#)

[EN \(pdf\)](#)

[FR \(pdf\)](#)

附件

可选附件

其他附件

[Clutch SP-006-0-WR513-11-2 Serie LP](#)

产品ID：10837142

以前的产品ID：474940.0112
