

## Voreinst. SK50/Bohrhaltestück D24mm

### Technische Daten

WZH Zubehörkategorie

Adapter für Voreinstellgeräte

Aufnahme

SK50 für Voreinstellgeräte

Werkzeugaufnahme

Bohrhaltestück D24mm

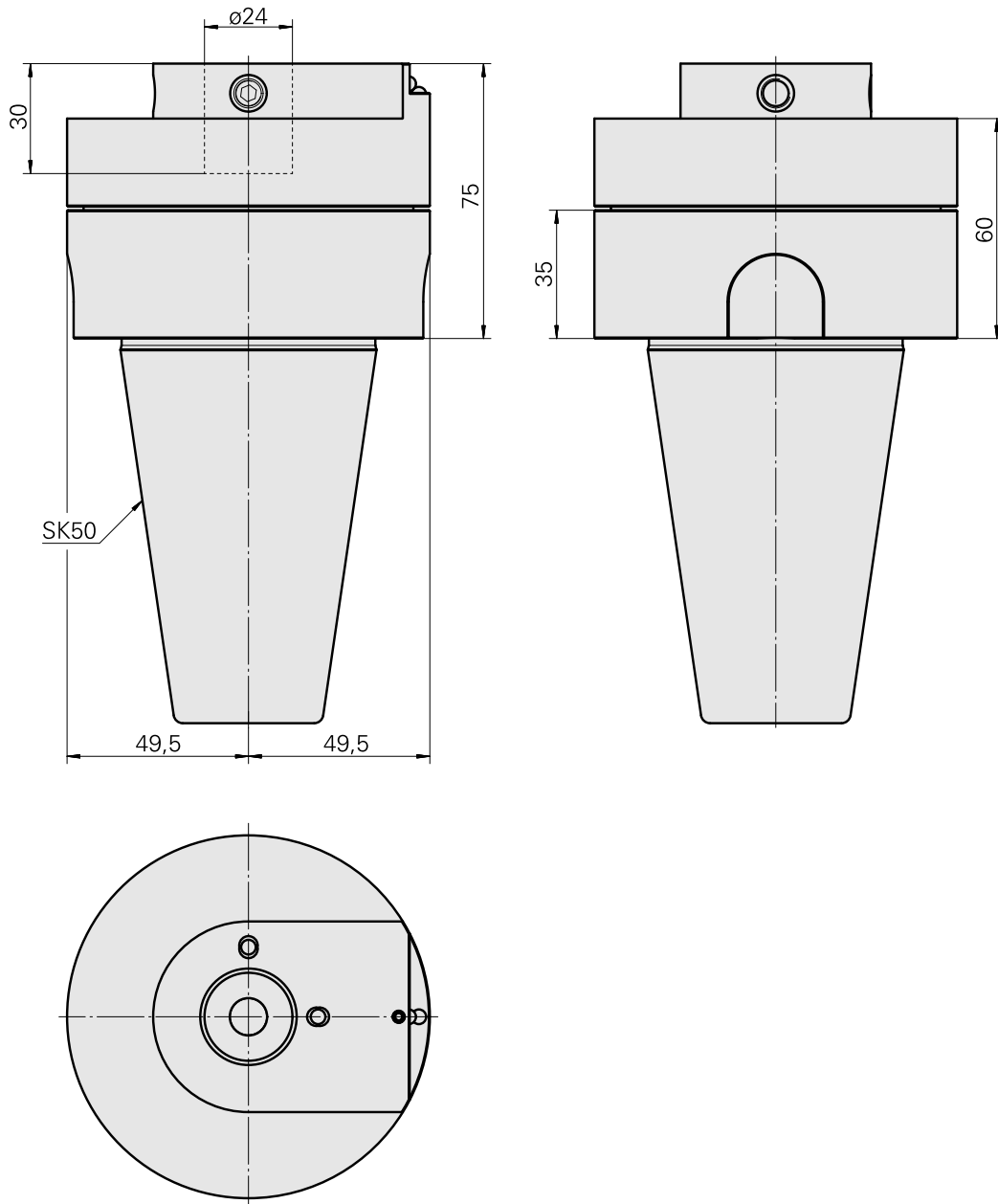
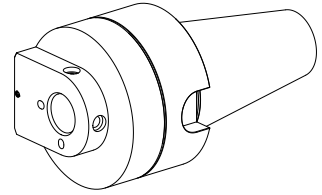

## **Dokumente**

Für dieses Produkt sind keine Downloads vorhanden