

Mount

Données techniques

Catégorie d'accessoires PO

Adaptateur cube de pré réglage

Logement d'outils

VDI 40

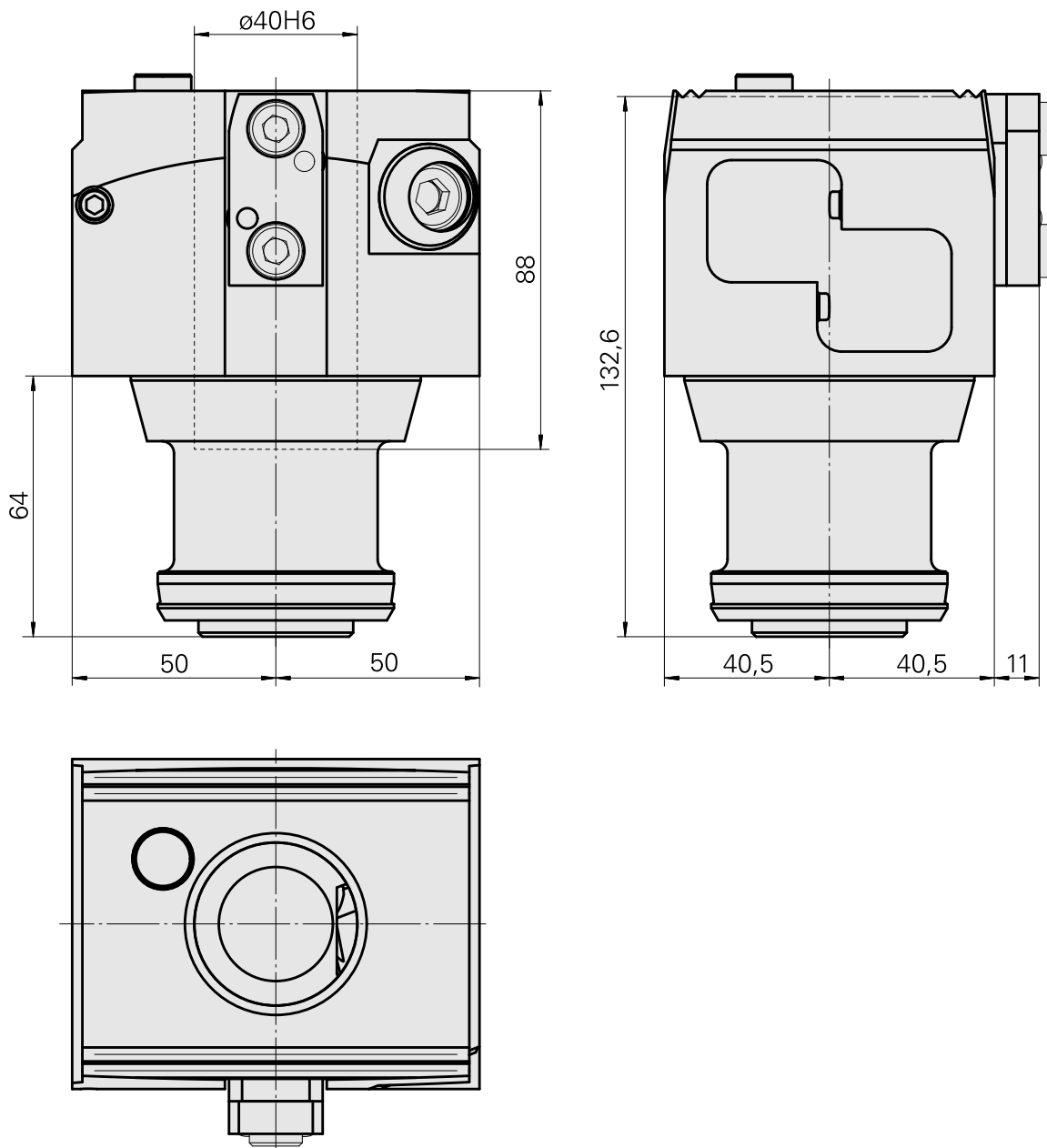
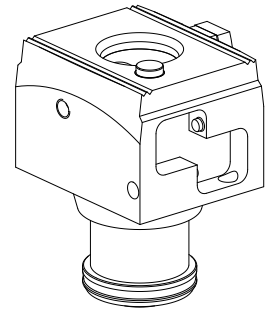

Documents

Aucun téléchargement n'est disponible pour ce produit