

WFB 32-20 D8

Technical data

TH accessories category

WFB 32-20

Mounting

D8

Quick change inserts

Weldon mounting

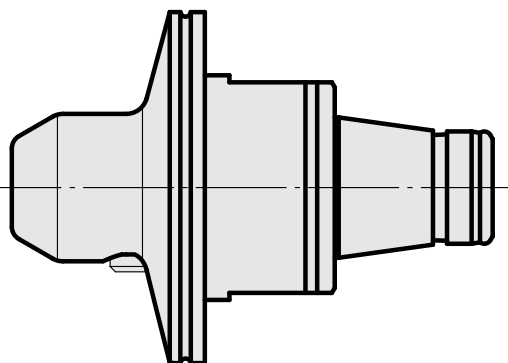
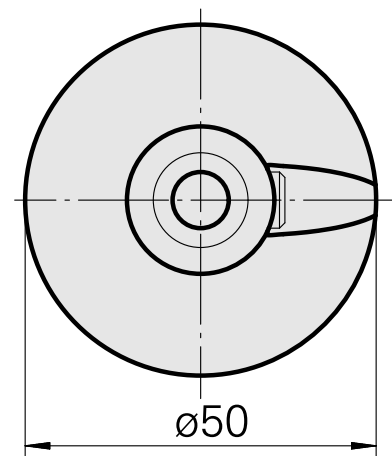

10851486
836271

INDEX

Documents

No downloads available for this product