

Saw blade, circular saw blade width 6 mm (0.23")

Technical data

TH accessories category

Circular saw blade d125

Tool mounting

22mm

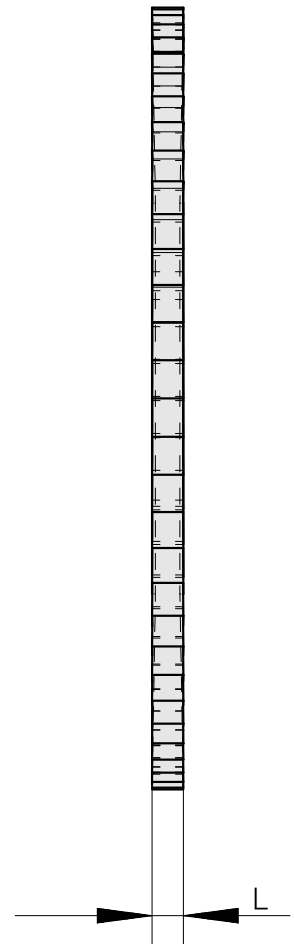
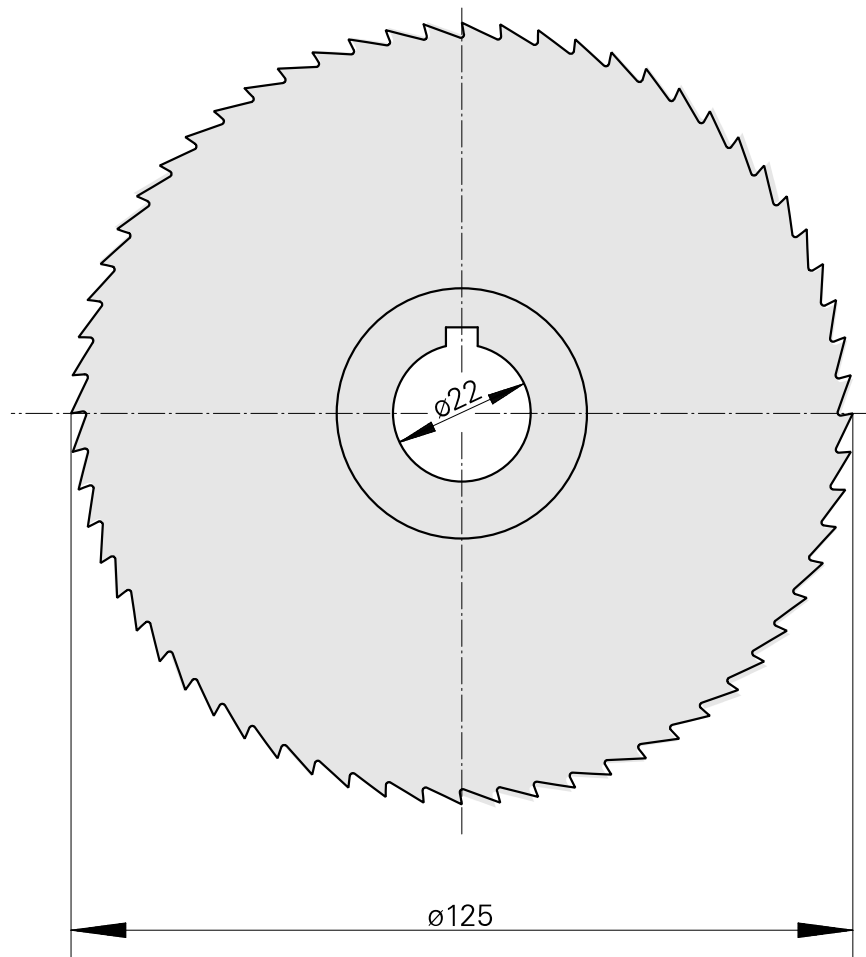
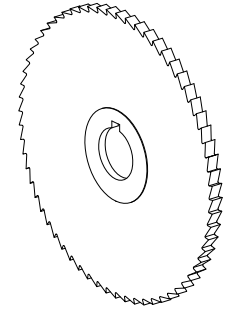

10786817
223015.2560

INDEX

Documents

No downloads available for this product