

用于丝锥的ER夹头 ET 1-32 4,5mm

技术特点

刀座附件类别
夹具
刀具夹具
夹头型号

用于丝锥的ER夹头
ER32
4,5mm
ET 1-32

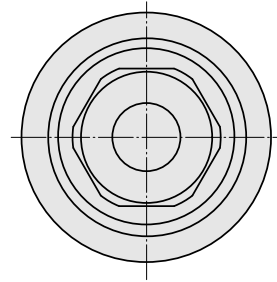
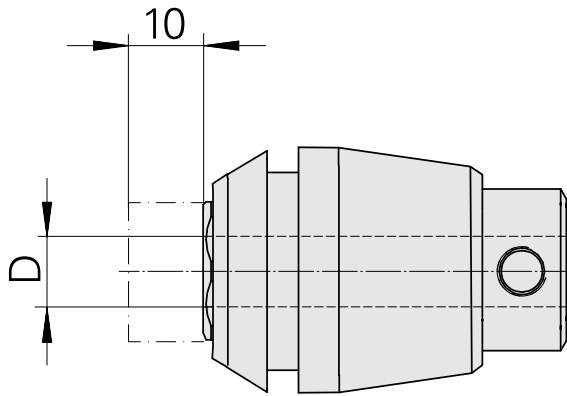
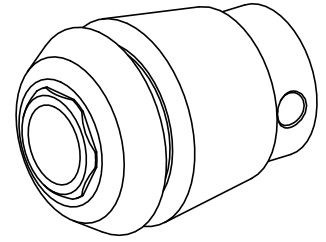

文件

没有针对此产品的任何下载