

适配器组装辅助 INDEX CAPTO C3

技术特点

刀座附件类别
刀具夹具

适配器组装辅助
INDEX CAPTO C3

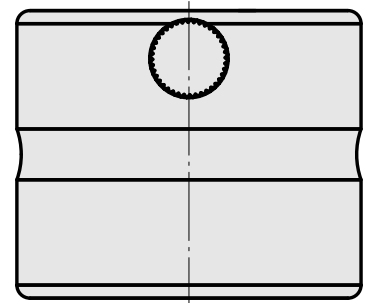
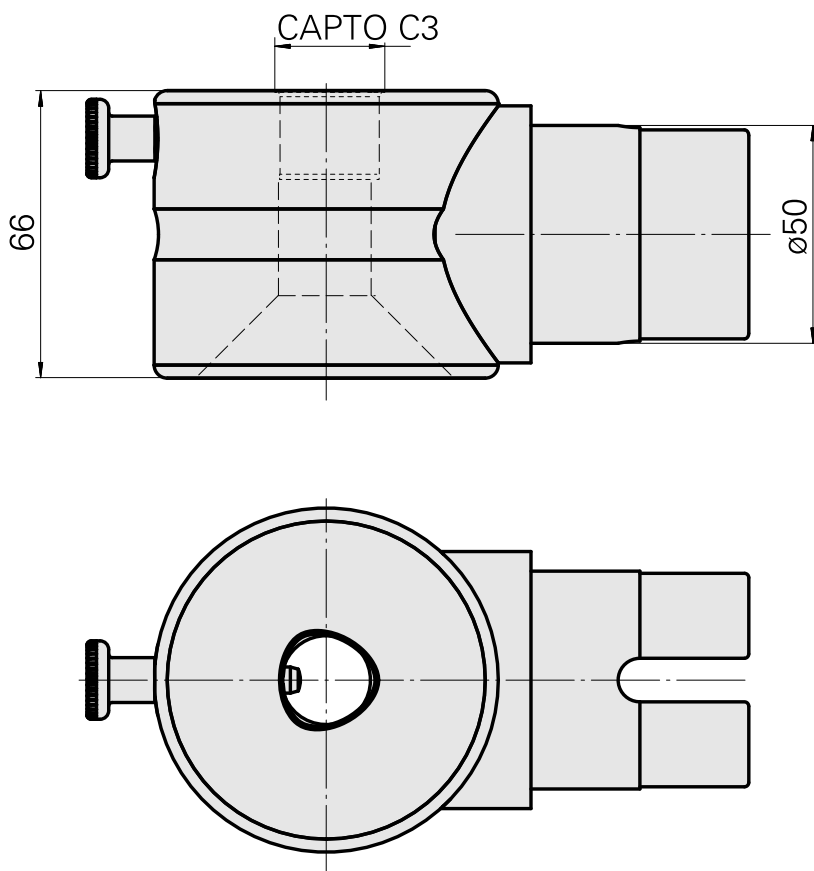
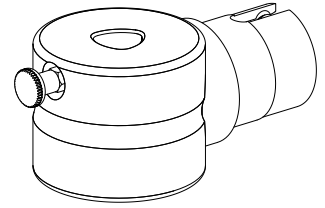

文件

没有针对此产品的任何下载