

Clamping nut

技术特点

刀座附件类别
夹具
夹头型号
紧固螺母型号

紧固螺母
ER11
ER 11
外螺纹

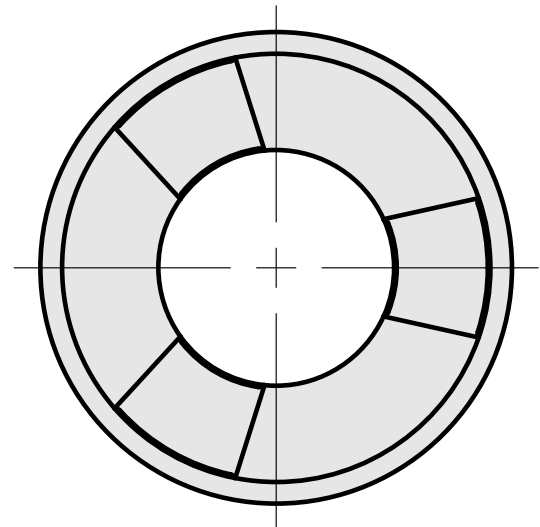
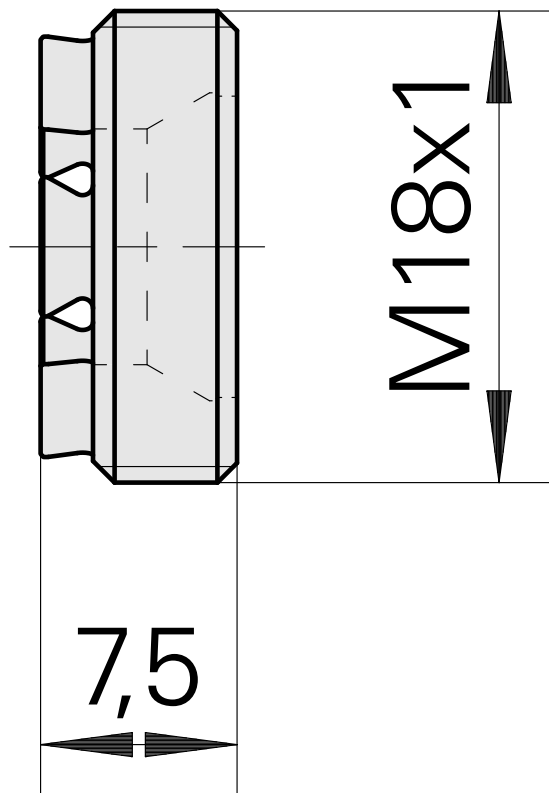
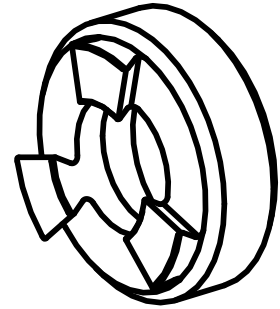

文件

没有针对此产品的任何下载