

## Centering drill, 60° D28 mm (1.10") for hollow parts

### Technical data

TH accessories category

Center, universal

Mounting

D11.2/Cone 1:7.5

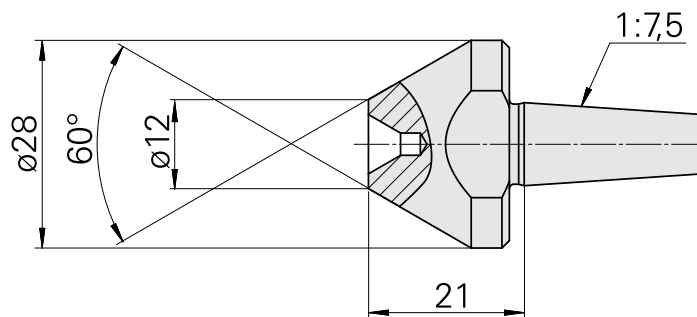
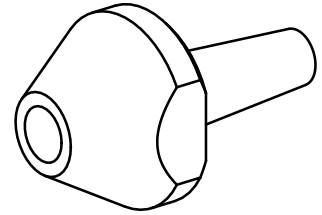

## **Documents**

No downloads available for this product