

Drilling tool holder VDI 30 D8, Form E2

Technical data

Shank VDI	VDI 30
Drive	not live
Fixation VDI	none
Cooling	external and internal
Pressure	20 bar
Mounting	D8
reversible 180°	no
Data carrier	check tool station bore
X [mm]	60 (2.36")
Y [mm]	-
Z [mm]	-
INDEX TRAUB products	V100 • V200 • V160C • V160G • V300 • TNA300

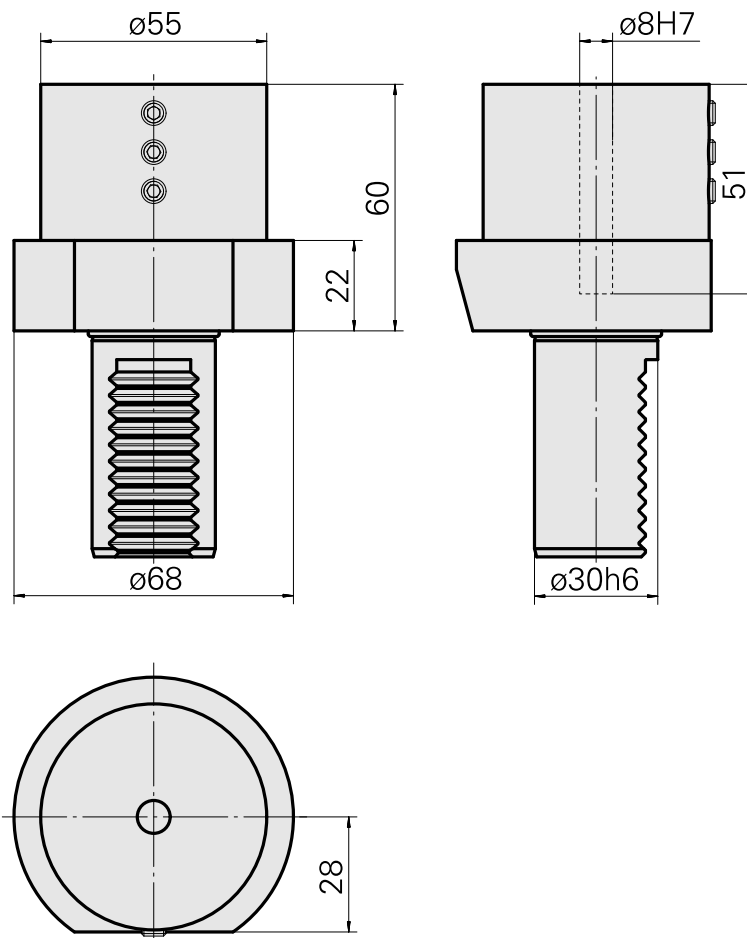
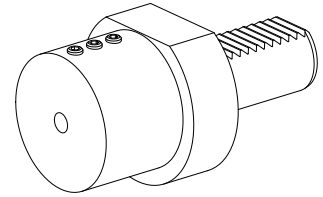

Documents

No downloads available for this product