

Adaptor

技术特点

刀座附件类别
夹具
刀具夹具

对刀仪转接器
D80用于预设设备
MS32/MS40 横向溜板

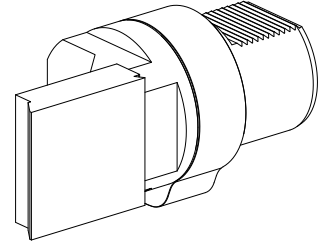

针对此产品，目前没有3面视图

文件

没有针对此产品的任何下载