

Milling cutter holding block Milling sha

Technical data

Drive

not live

Mounting

Milling shaft D16

X [mm]

—

Y [mm]

—

Z [mm]

—

INDEX TRAUB products

A100 • C42/65 • G160 • G300 •
G400 • MS32C • MS52C • TNX80
• V100 • V200 • A200-6 • ABC
• B400 • C100 • C200 • G200 •
G200.2 • G220 • G250 • MS16-6
• MS22-6 • MS22-8 • MS32-6.2 •
MS40-6 • MS40-8 • TNX65/42 •
V160C • V160G • V300 • TNA400.2
• ABC.2 • G300.2 • G320.2 • B400.3
• TNA400.3

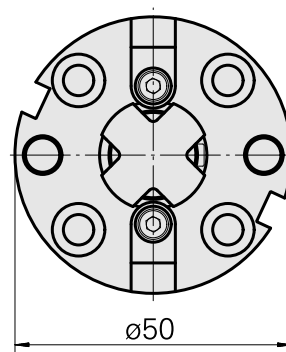
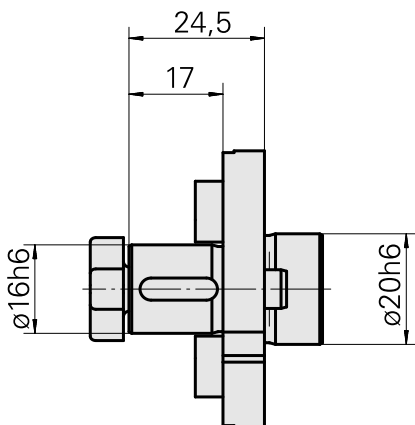
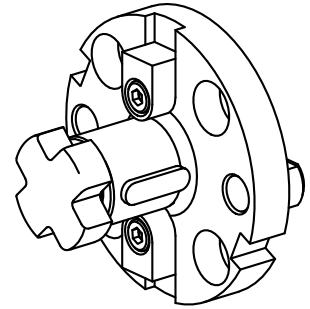

Documents

No downloads available for this product

Accessories

Required for operation

[mill arbor wrench](#)

Product ID : 10007866

Previous product ID : 203020.1160

TH accessories
category
Tool

Mounting
Milling shaft D16

Tools for Collet chucks
Mill arbor wrench

Optional accessories

Tool holder accessories

[Screw](#)

Product ID : 10381768

Previous product ID : 250122.0820

TH accessories
category
Cutter tightening screw

Mounting
M8

Other accessories

[Ring](#)

Product ID : 10398855

Previous product ID : 251390.----

[Ring](#)

Product ID : 10169490

Previous product ID : 251391.----
