

## Clamping collet 138E/F20 Ø=15,00

### Technical data

Clamping device size	138E/F20
manufacturer product line	
Clamping type	smooth
Nominal diameter (mm)	15 Millimeter
Clamping method	External clamping
Collet version	Slots vulcanized (standard)
manufacturer product line	Schlenker

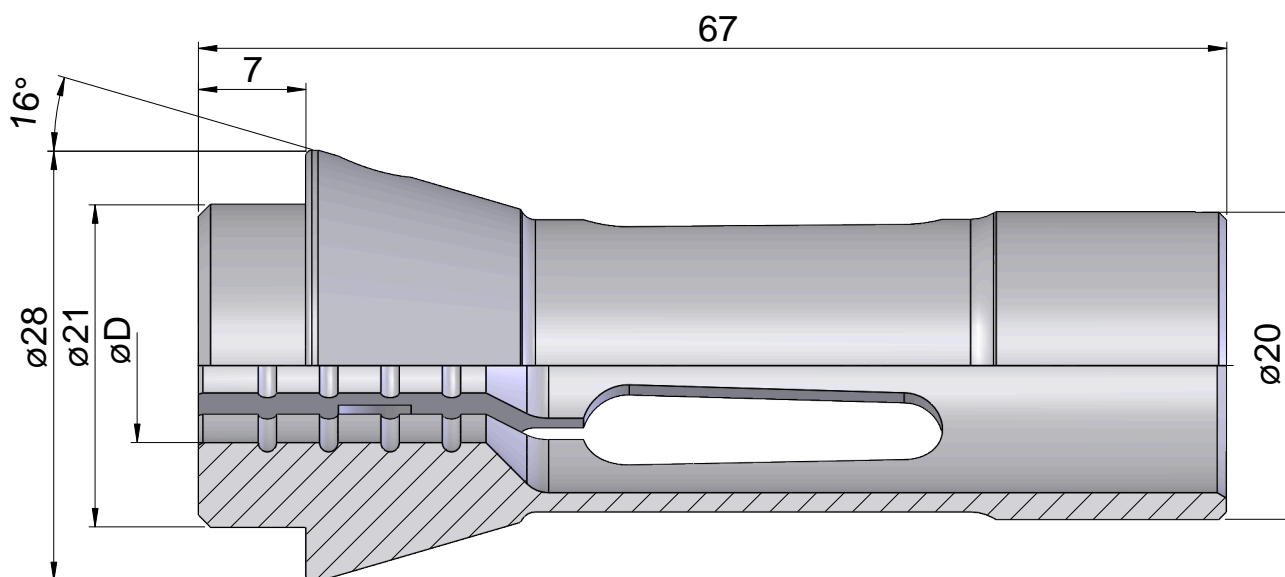
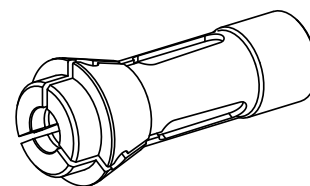

## **Documents**

No downloads available for this product