

Turning tool holder KPS 45 square 16x16

Technical data

Shank KPS	KPS 45
Drive	not live
Cooling	external and internal
Mounting	Square 16x16
Pressure	80 bar
X [mm]	79 (3.11")
Y [mm]	-
Z [mm]	-14 (-0.55)
INDEX TRAUB products	TNL18 • TNL20 • TNL32-11 • TNL32 • TNL32-11 compact • TNL20-11 • TNL32 compact • TNK40.2-10 • TNK40.2-8 • TNL20.2

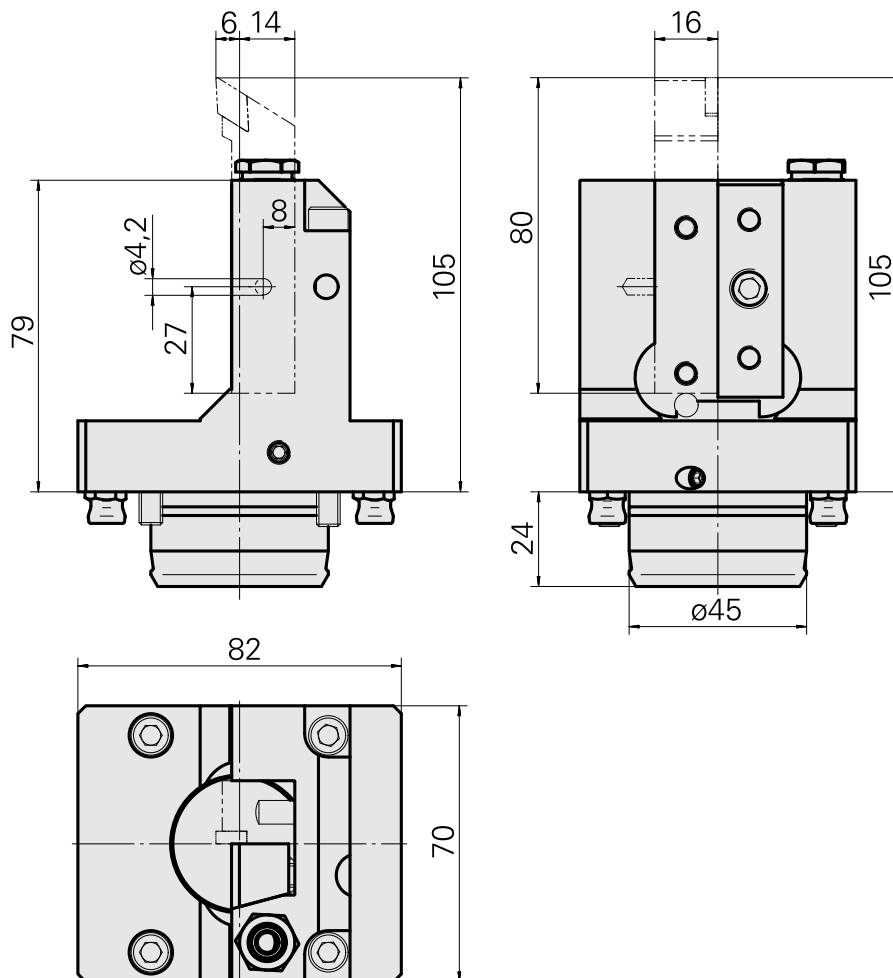

Documents

No downloads available for this product

Accessories

Optional accessories

Tool holder accessories

[Coolant tube, L=100 mm \(3.93"\)](#)

Product ID : 10346684

Previous product ID : W9990559

TH accessories
category
Cooling lubricant tube

Mounting
M6

Other accessories

[Cover f. Drehhalter 16x16](#)

Product ID : 10141942

Previous product ID : W9991072

[Coolant Nozzle](#)

Product ID : 11031912

Previous product ID : W67500.3208

[Nozzle Kugel D10 - Bohrung D2 40°](#)

Product ID : 10072335

Previous product ID : 910693

[BUSHING 10 D x 6 D x 12,5](#)

Product ID : 10670360

Previous product ID : W67530.0824

10791922
W7040056

INDEX

HOLLOW SCREW M14x1 M14x1

Product ID : 10105238
Previous product ID : W67530.0818

Nozzle M6 mit D1,6

Product ID : 10147428
Previous product ID : W00019.0216

Grub screw M14x1

Product ID : 10231477
Previous product ID : P68451.90
