

## Clamping head TOP65 G D=5,00mm

### Technical data

<b>Clamping device size</b>	SK65
<b>manufacturer product line</b>	TOPlus chuck
<b>Clamping type</b>	smooth
<b>Nominal diameter (mm)</b>	5 Millimeter
<b>Clamping method</b>	External clamping
<b>manufacturer product line</b>	Hainbuch

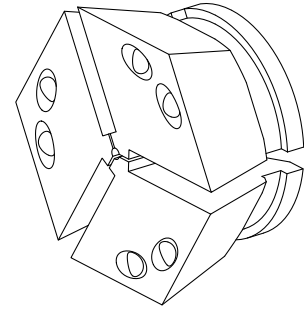

No 3-side view is currently available for this product

## **Documents**

No downloads available for this product