

## WFB 20-12 Milling shaft D16, with cutter tightening screw

### 技术特点

刀座附件类别  
夹具  
快换夹头

WFB 20-12  
铣削轴 D16  
带铣刀杆刀柄

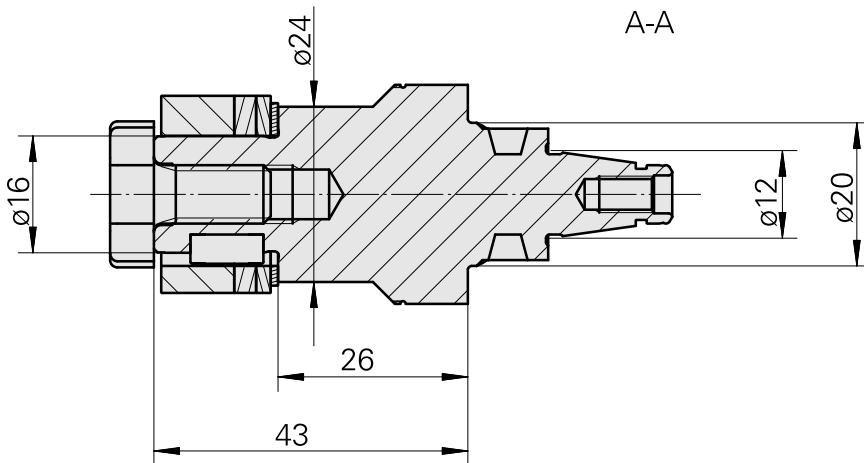
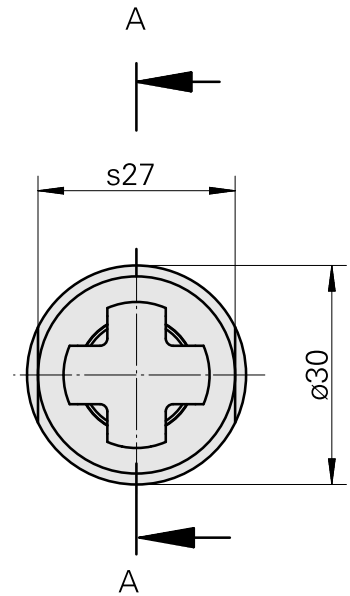
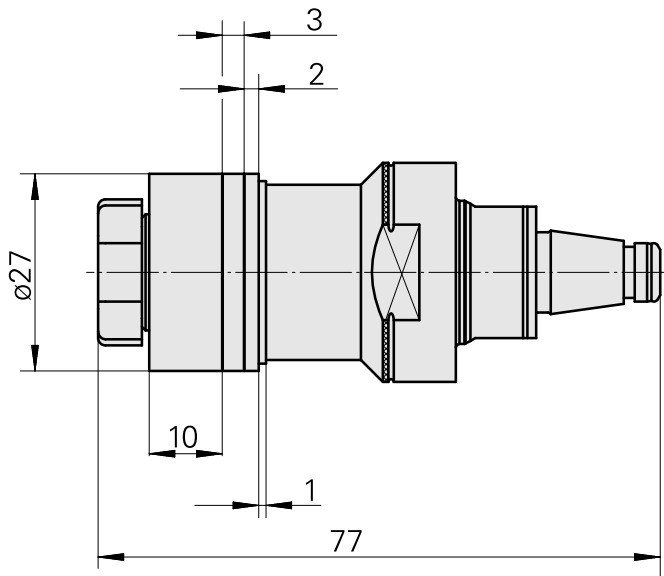
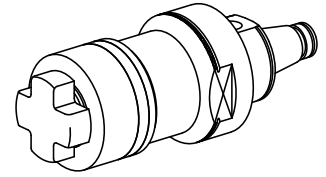

## 文件

没有针对此产品的任何下载

## 附件

转至运行所需

### [mill arbor wrench](#)

产品ID：10007866

以前的产品ID：203020.1160

刀座附件类别  
用于夹头的工具

夹具  
铣削轴 D16

夹头工具  
铣削芯轴扳手

## 可选附件

### **Tool holder accessories**

#### [Screw](#)

产品ID：10381768

以前的产品ID：250122.0820

刀座附件类别  
铣刀锁紧螺栓

夹具  
M8

## 其他附件

#### [Ring](#)

产品ID：10398855

以前的产品ID：251390.-----

#### [Ring](#)

产品ID：10169490

以前的产品ID：251391.-----