

WFB 32-20 D20

Technical data

TH accessories category	WFB 32-20
Mounting	D20
Quick change inserts	Weldon mounting

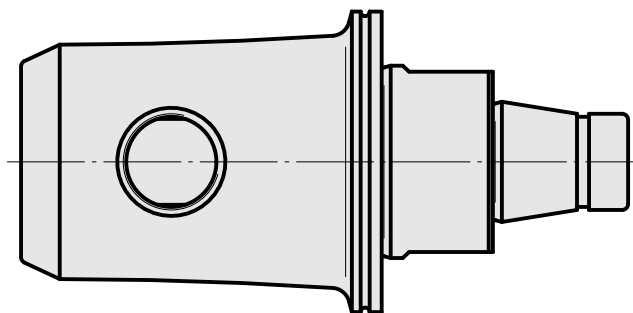
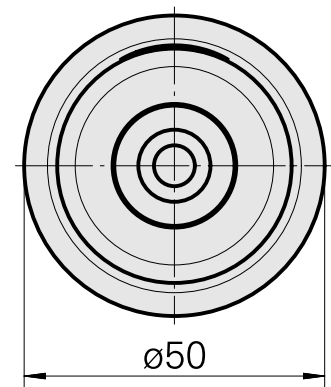
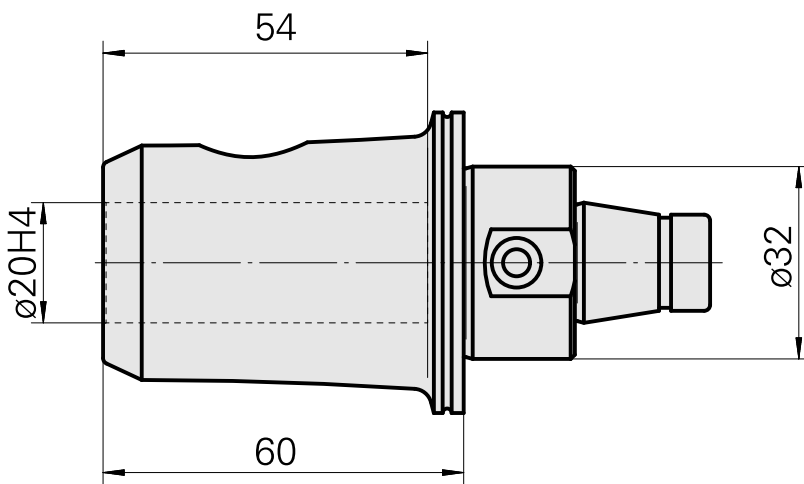
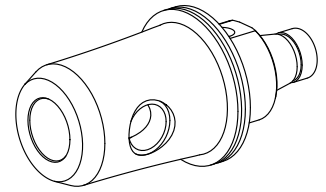

Documents

No downloads available for this product

Accessories

Optional accessories

Other accessories

[Mounting sleeve with collar D20](#)

Product ID : 10063939

Previous product ID : W68510.04--
