

## Grooving tool holder MS32/MS40 Forming t

### Technical data

<b>Slide system MS</b>	MS32/MS40
<b>Drive</b>	not live
<b>Fixation MS</b>	Dovetail
<b>Cooling</b>	external
<b>Pressure</b>	40 bar
<b>Direction</b>	right-handed run
<b>Mounting</b>	Forming tool AWN 20
<b>X [mm]</b>	43 (1.69")
<b>Y [mm]</b>	–
<b>Z [mm]</b>	29 (1.14)
<b>INDEX TRAUB products</b>	MS32C • MS32-6.2 • MS40-6 • MS32-6.3

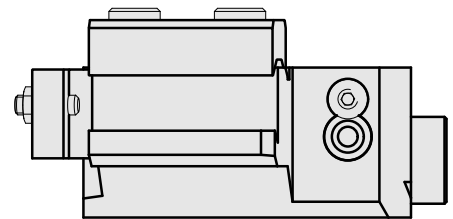
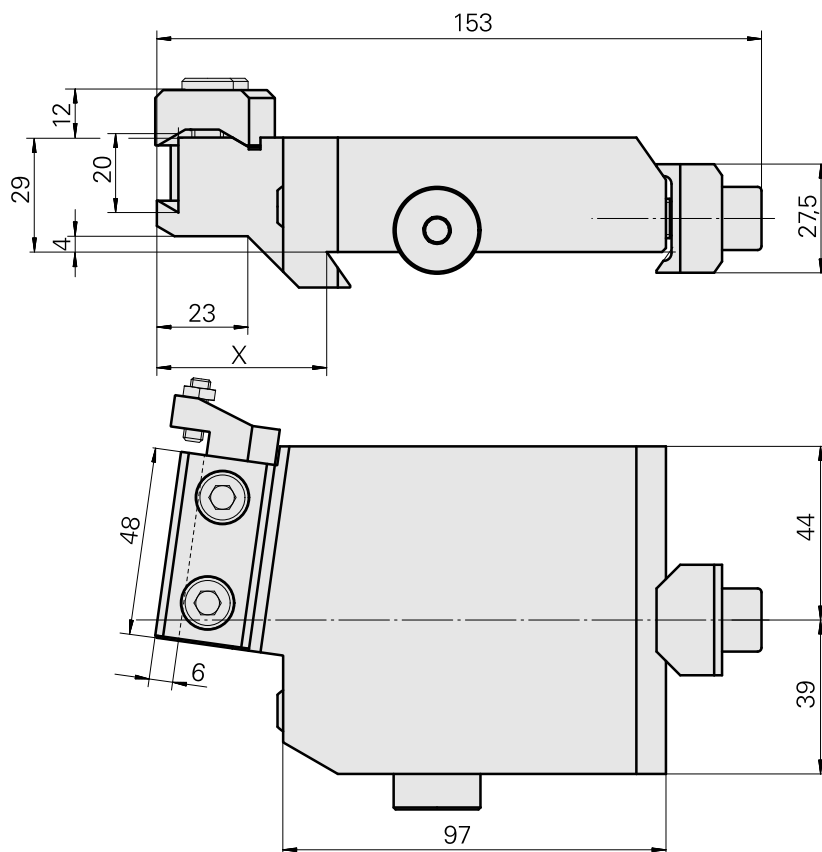
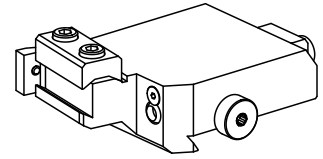

X	43
---	----

## Documents

No downloads available for this product

## Accessories

Optional accessories

### Other accessories

#### [Tube Kugel 12 D](#)

Product ID : 10481964

Previous product ID : W63490.0022

---

#### [Countersunk screw 8.8 Torx M 5x12 14581 M 5x12/T25 verzinkt 402315 12](#)

Product ID : 10607371

Previous product ID : 410362.0512

---