

Saw blade, circular saw blade width 1.6 mm (0.06")

Technical features

TH accessories category

Circular saw blade d80

Tool mounting

16 mm

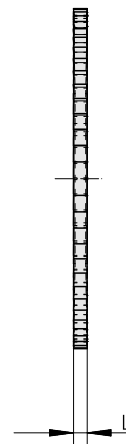
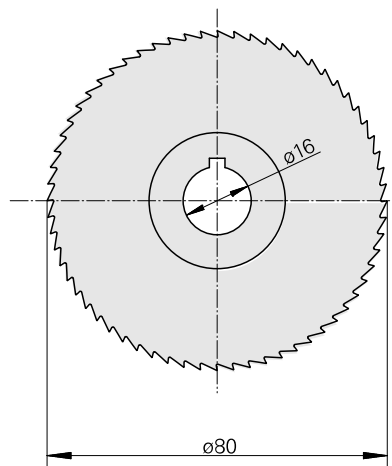
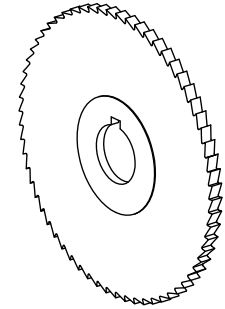

10380724
223011.8016

INDEX

Documents

No downloads available for this product