

## WFB 32-20 D6

### Technical data

TH accessories category

WFB 32-20

Mounting

D6

Quick change inserts

Weldon mounting

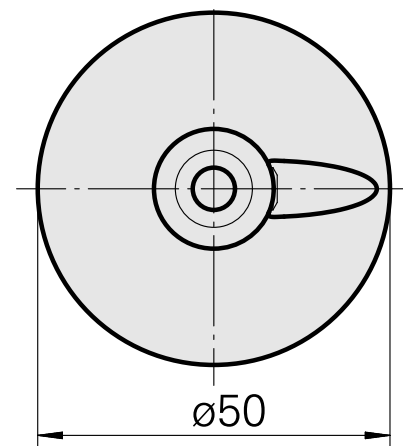
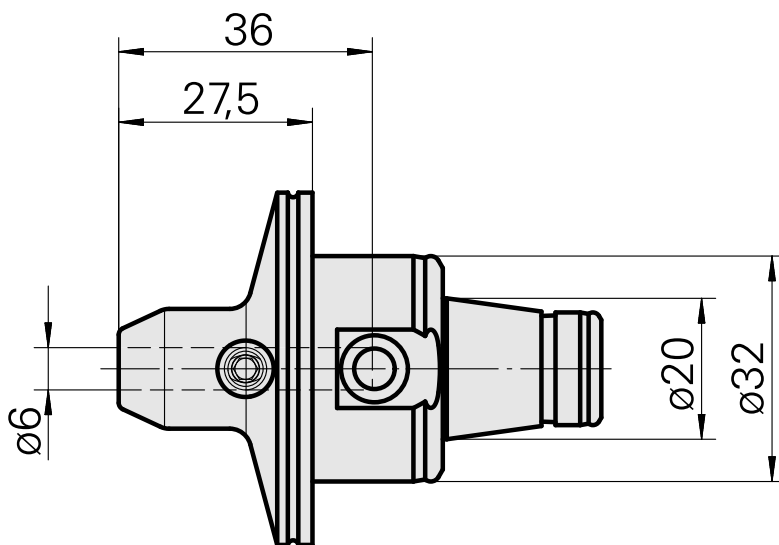
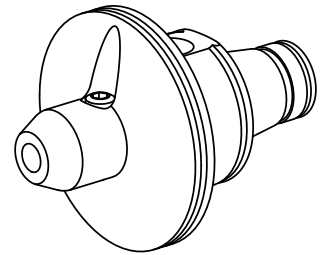

10108972  
836270

**INDEX**

---

## **Documents**

No downloads available for this product