

Probe holder KPS 45 Renishaw D11,2

Technical features

Shank KPS	KPS 45
Drive	not live
Cooling	external
Mounting	Renishaw D11,2
Pressure	80 bar
X [mm]	38 (1.50")
Y [mm]	-
Z [mm]	-
INDEX TRAUB products	TNL20 • TNL32 • TNL32-11 • TNL32-11 compact • TNL32 compact

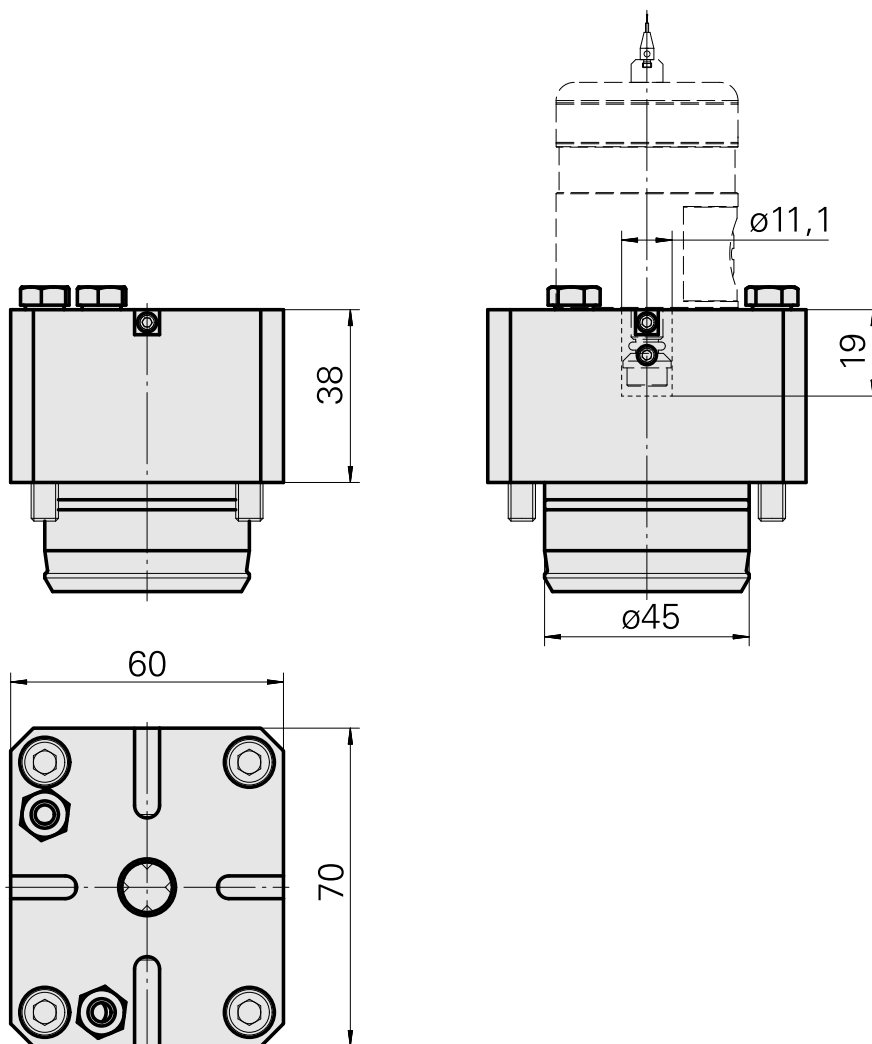
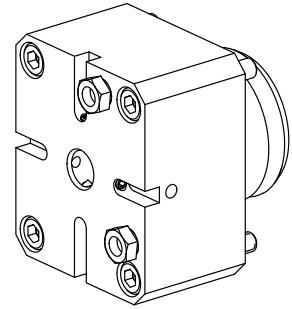

Documents

No downloads available for this product

Accessories

Required for operation

Not defined

Product ID : 12133465

Previous product ID :

Push-button insert

Product ID : 12133466

Previous product ID :

Probe

Product ID : 10338967

Previous product ID : 487542.1441

Optional accessories

Tool holder accessories

Coolant tube, L=100 mm (3.93")

Product ID : 10309869

Previous product ID : W9990658

TH accessories
category
Cooling lubricant tube

Mounting
D6

Other accessories

Conical ring DIN 3862-6-St

Product ID : 10528470

Previous product ID : 471060.0601

10089784
W7040029

INDEX

THREADED BUSHING M10x1 Stahl verzinkt A3C

Product ID : 10707394
Previous product ID : 471112.06

Case A-2033-7001

Product ID : 10259626
Previous product ID : 487542.0911
