

Turning tool holder KPS 45 square 20x20

Technical data

Shank KPS	KPS 45
Drive	not live
Cooling	external, internal optional
Mounting	Square 20x20
Pressure	80 bar, internal 160 bar opt.
X [mm]	85 (3.35")
Y [mm]	–
Z [mm]	-19 (-0.75)
INDEX TRAUB products	TNL20 • TNL32 • TNL18 • TNL32-11 • TNL32-11 compact • TNL20-11 • TNL32 compact • TNK40.2-10 • TNK40.2-8 • TNL20.2

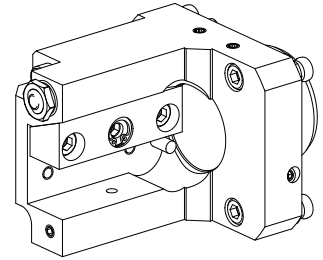

Note

Internal cooling lubricant supply with 160 bar is possible only on stations with an additional fluid-transfer station!
Internal cooling lubricant supply with 160 bar is possible only on stations with an additional fluid-transfer station!

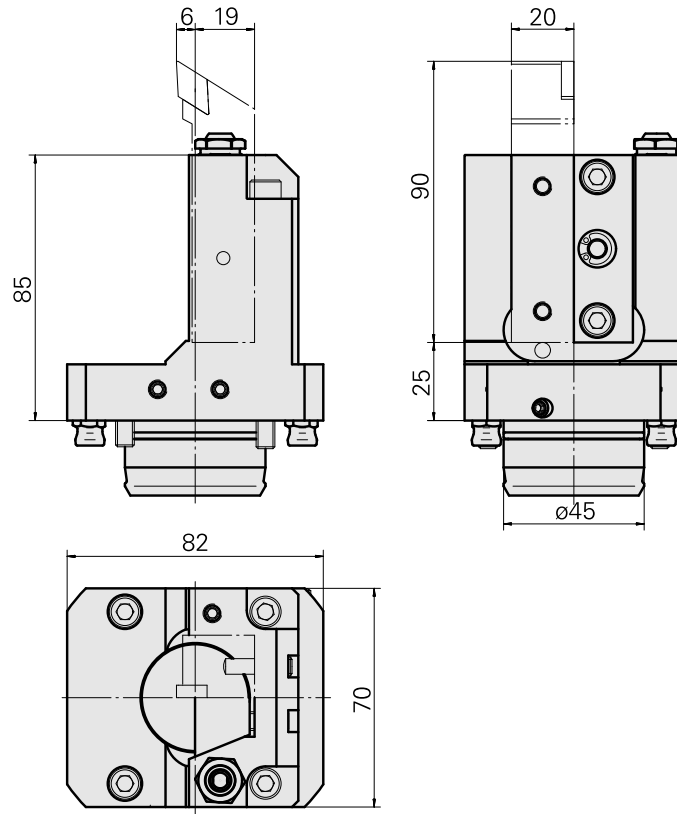

Documents

No downloads available for this product

Accessories

Optional accessories

Tool holder accessories

[Coolant tube, L=100 mm \(3.93"\)](#)

Product ID : 10346684

Previous product ID : W9990559

TH accessories
category
Cooling lubricant tube

Mounting
M6

Other accessories

[Coolant Nozzle](#)

Product ID : 11031912

Previous product ID : W67500.3208

[Nozzle Kugel D10 - Bohrung D2 40°](#)

Product ID : 10072335

Previous product ID : 910693

[BUSHING 10 D x 6 D x 12,5](#)

Product ID : 10670360

Previous product ID : W67530.0824

[HOLLOW SCREW M14x1 M14x1](#)

Product ID : 10105238

Previous product ID : W67530.0818

10081299
W7040108

INDEX

[Nozzle M6 mit D1,6](#)

Product ID : 10147428

Previous product ID : W00019.0216
