

INDEX CAPTO C3 Fräswelle D16, mit Fräseranzugsschraube

Technische Daten

WZH Zubehörcategorie

INDEX CAPTO C3

Aufnahme

Fräswelle D16

Schnellwechseleinsätze

Fräsdornaufnahme

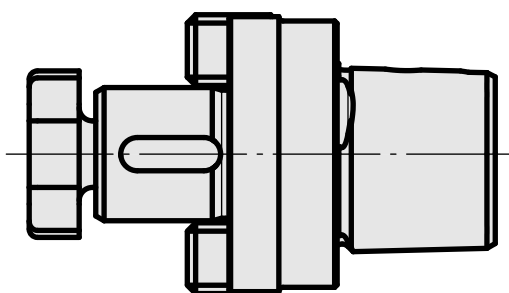
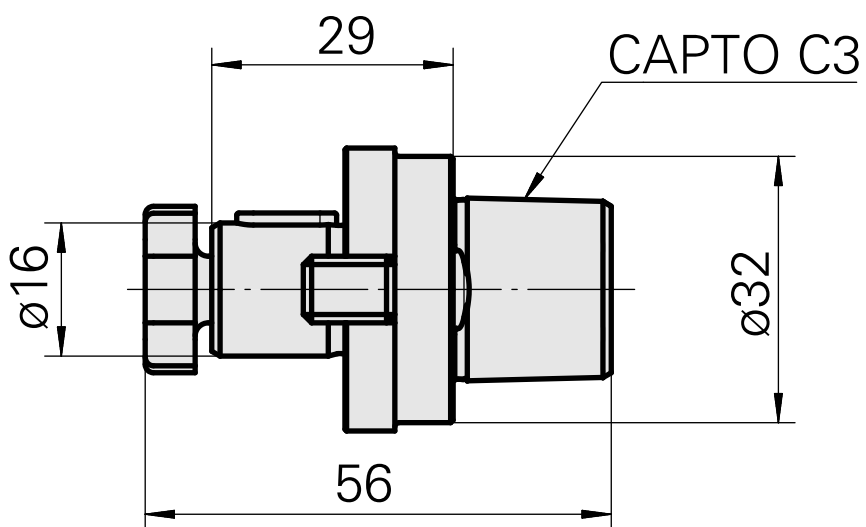
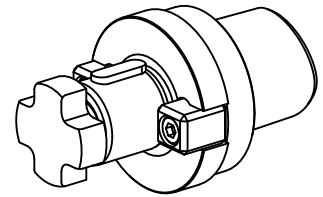

Dokumente

Für dieses Produkt sind keine Downloads vorhanden

Zubehör

Zum Betrieb benötigt

Fräsdornschlüssel 16

Artikel-Id : 10007866

frühere Artikel-Id : 203020.1160

WZH Zubehörkategorie
Werkzeug für
Spannzangen

Aufnahme
Fräswelle D16

Werkzeug für
Spannzangen
Fräsdornschlüssel

Optionales Zubehör

Zubehör für Werkzeughalter

Fräseranzugsschraube M8

Artikel-Id : 10381768

frühere Artikel-Id : 250122.0820

WZH Zubehörkategorie
Fräseranzugsschraube

Aufnahme
M8