

## WFB 20-12 Espansione idraulica D10

### Données techniques

Catégorie d'accessoires PO

WFB 20-12

Attachement

Hydroexpansible D10

Inserts à changement rapide

avec attachem. hydroexpansible

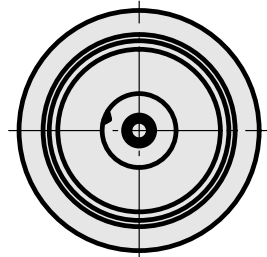
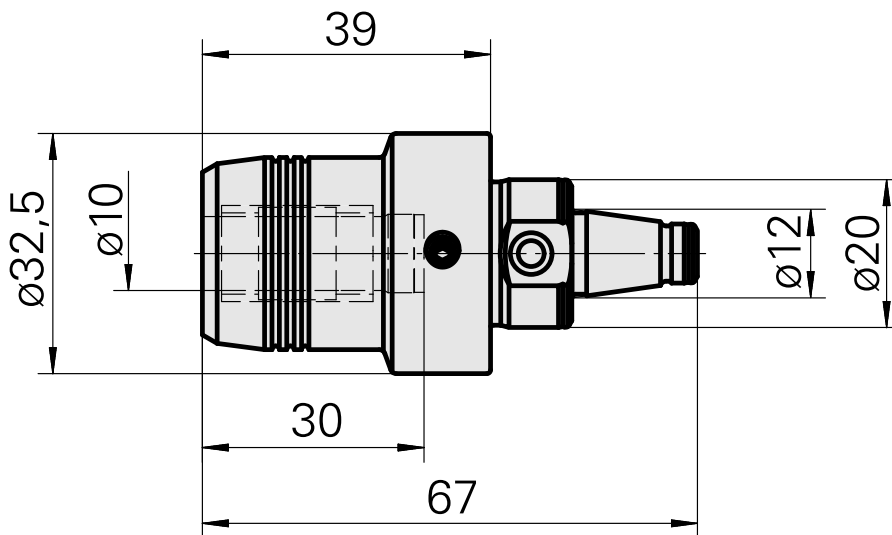
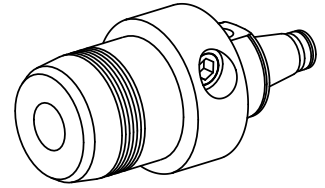

## **Documents**

### **Remarques concernant les produits**

[DE \(pdf\)](#)

[EN \(pdf\)](#)

[FR \(pdf\)](#)