

Testa per alesare per VB.. 1604..

Caratteristiche tecniche

Attacco	per VB.. 1604..
Raffreddamento	interno
Pressione	50 bar
X [mm]	36
Z [mm]	45
Prodotti INDEX TRAUB	G420 • G520 • G320.2 • G220.3 • TNX220.3

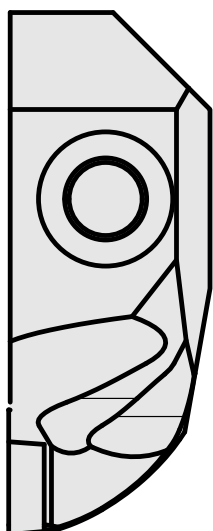
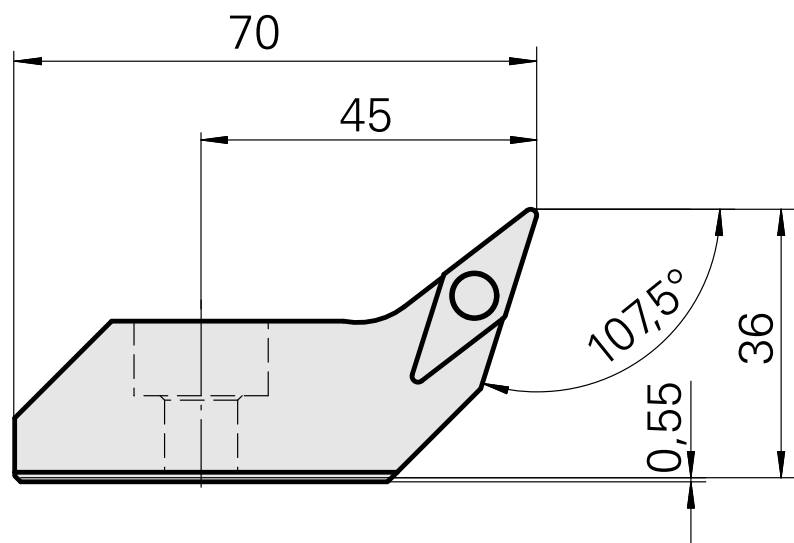
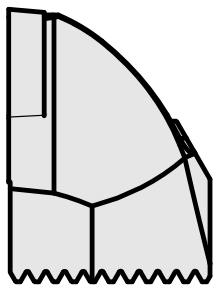
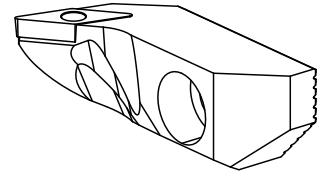

Documenti

Non sono disponibili download per questo prodotto