

Mount

技术特点

刀座附件类别

预调块座

刀具夹具

VDI 40

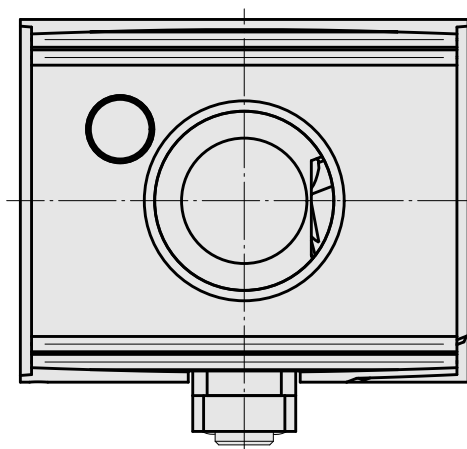
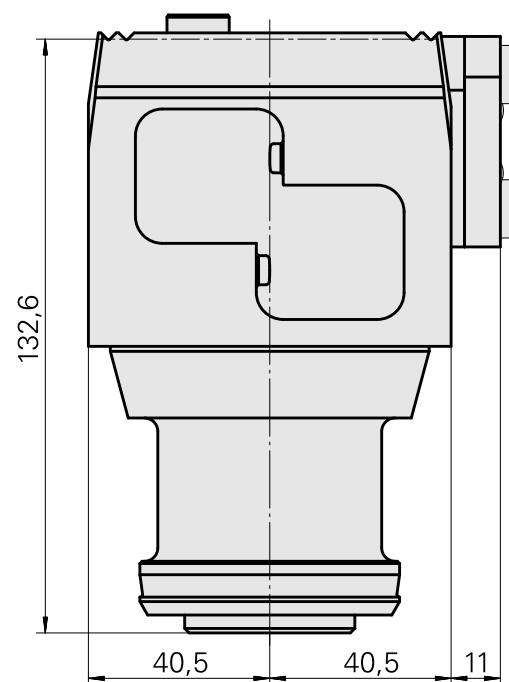
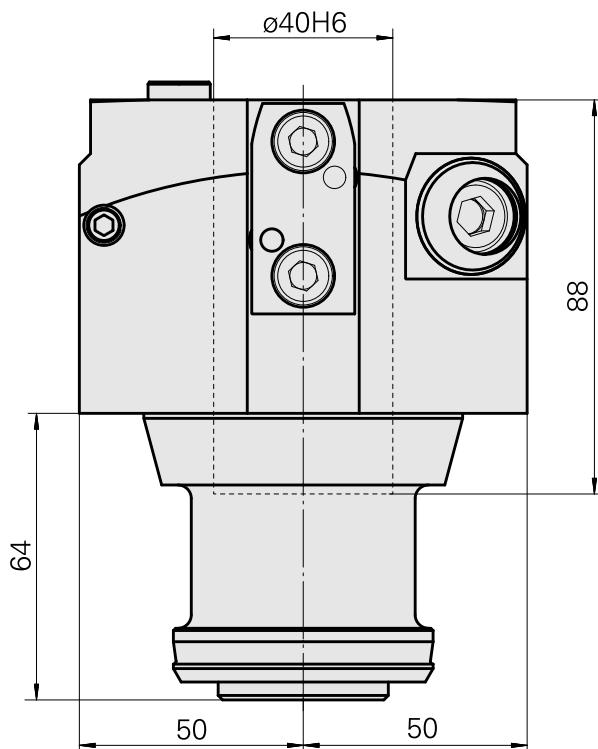
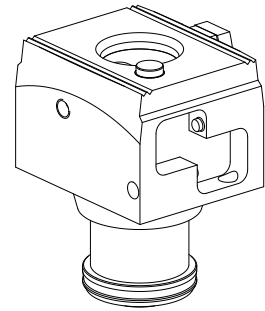

文件

没有针对此产品的任何下载