

ER-Gewindebohrspannzange ET1-12 2,2mm

Technische Daten

| | |
|----------------------|--------------------------|
| WZH Zubehörkategorie | ER-Gewindebohrspannzange |
| Aufnahme | ER11 |
| Werkzeugaufnahme | 2,2mm |
| Spannzangentyp | ET1-12 |

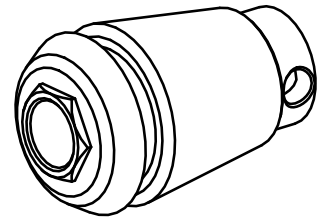

Dokumente

Für dieses Produkt sind keine Downloads vorhanden