

WFB 32-20 Attacco calettamento caldo D4

Caratteristiche tecniche

Categoria acces. portautensile

WFB 32-20

Attacco

Attacco calettamento caldo D4

Accessorio per cambio rapido

attacco caletta. a caldo

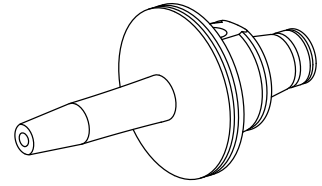

Documenti

Non sono disponibili download per questo prodotto