

Nastro da sega, larghezza lama sega circolare 2,5 mm

Caratteristiche tecniche

Categoria acces. portautensile

Lama sega circolare d63

Attacco per utensile

16mm

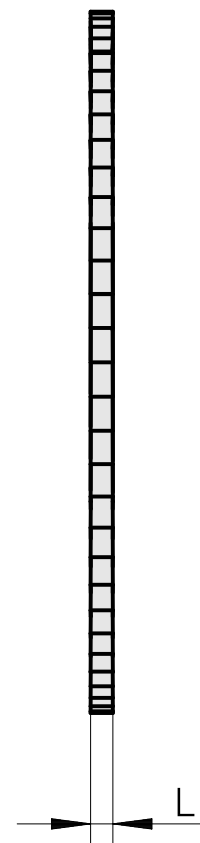
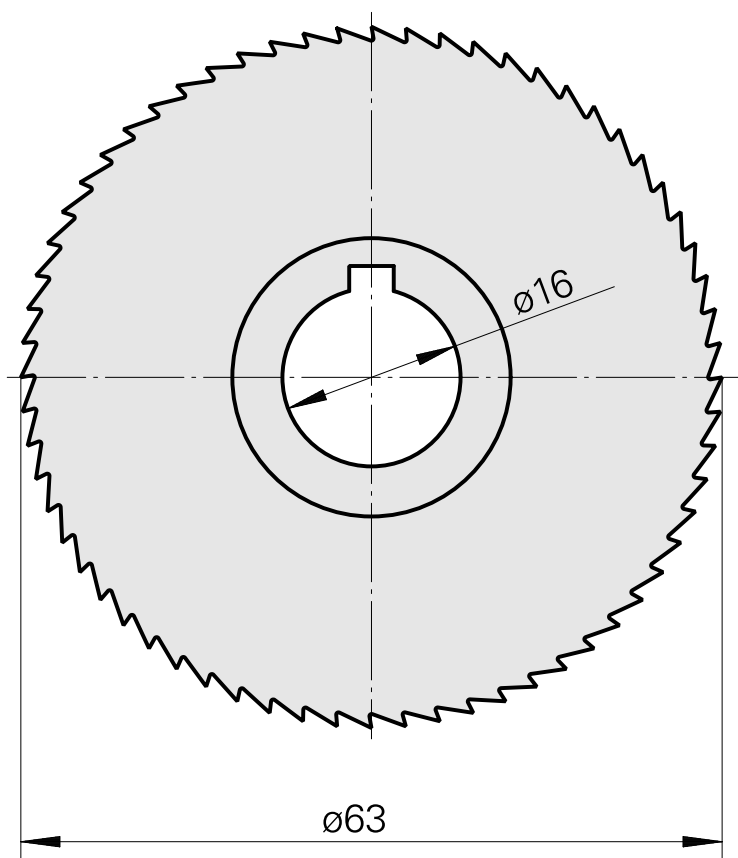

Documenti

Non sono disponibili download per questo prodotto