

WFB 20-12 Shrink-fit mounting D6

Technical data

TH accessories category

WFB 20-12

Mounting

Shrink-fit mounting D6

Quick change inserts

shrink-fit mounting

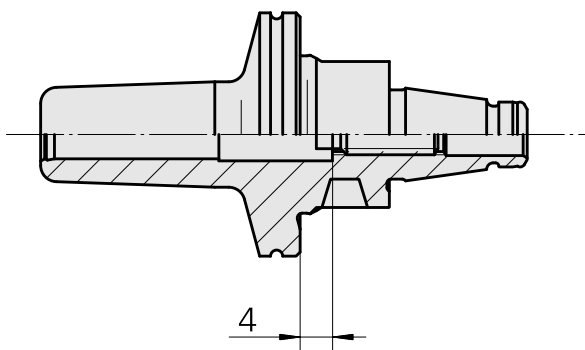
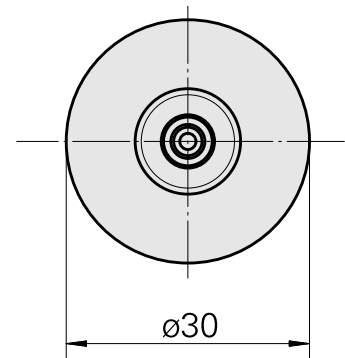
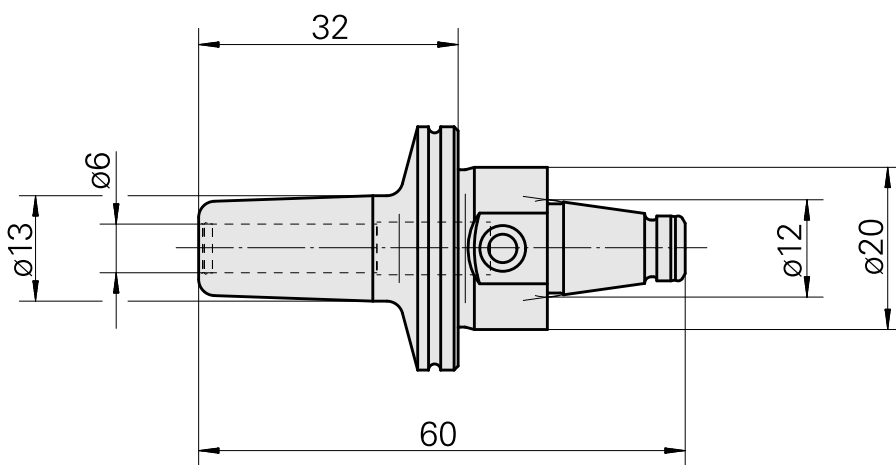
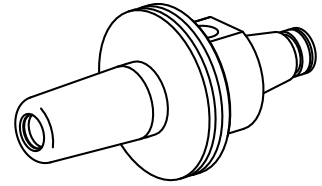

Documents

No downloads available for this product

Accessories

Optional accessories

Other accessories

[Adjusting screw M 5x15](#)

Product ID : 10491071

Previous product ID : 326794
