

INDEX CAPTO C3 per CN.. 1204.., sinistra, con scanalatura pinza

Caratteristiche tecniche

Categoria acces. portautensile

INDEX CAPTO C3

Attacco

per CN.. 1204..

Accessorio per cambio rapido

supporto portapezzo

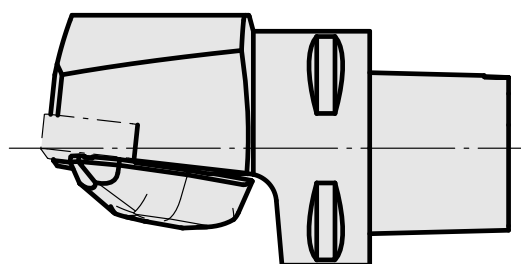
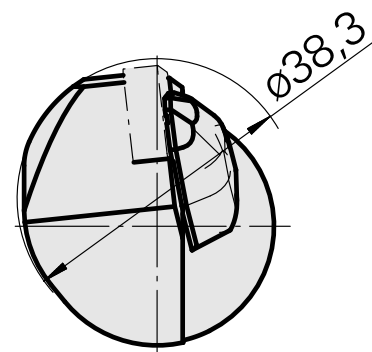
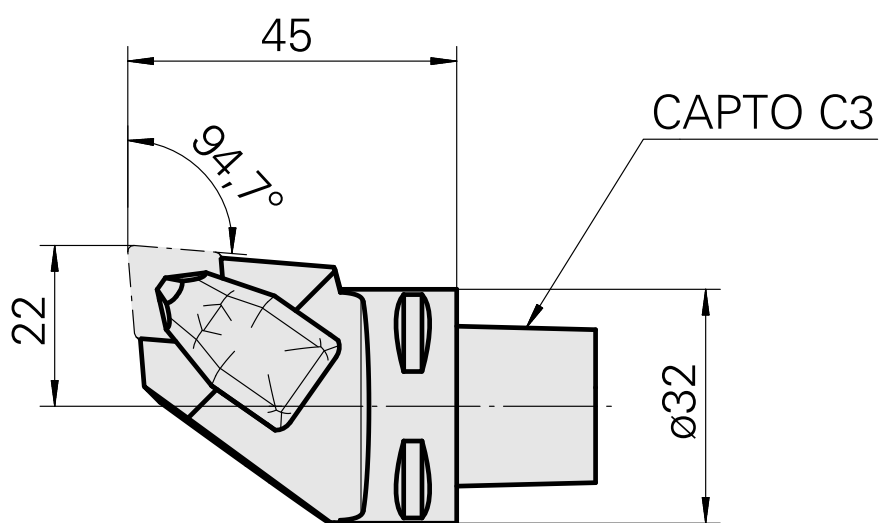
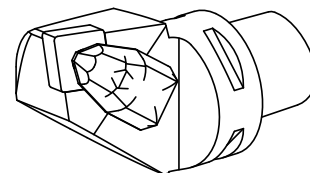

Documenti

Non sono disponibili download per questo prodotto