

Porte-foret HSK 25 C DIN 1835 B/E D10

Données techniques

Queue HSK	HSK 25
Forme HSK	C
Attachement	DIN 1835 B/E D10
Arrosage	central
Pression	40 bar
X [mm]	42
Produits INDEX TRAUB	MS22-6 • MS22-8 • MS16-6

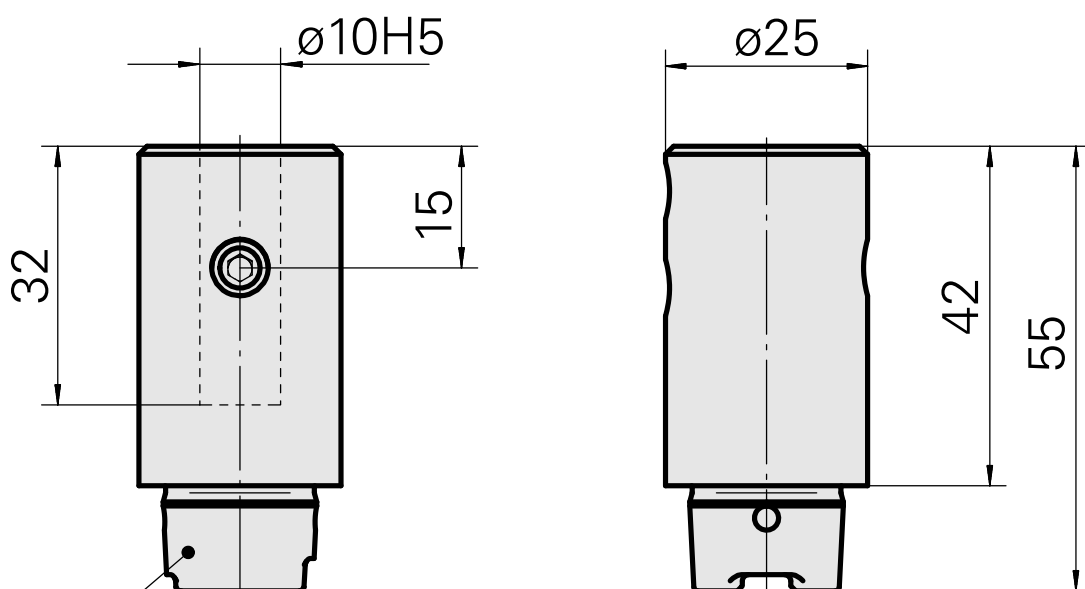
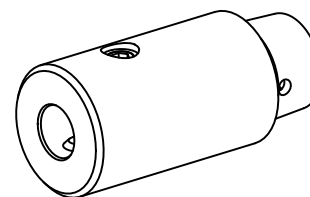

DIN 69893
HSK 25 C

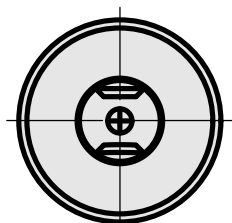

Documents

Aucun téléchargement n'est disponible pour ce produit