

## WFB 32-20 Shrink-fit mounting D8

### Technical data

TH accessories category

WFB 32-20

Mounting

Shrink-fit mounting D8

Quick change inserts

shrink-fit mounting

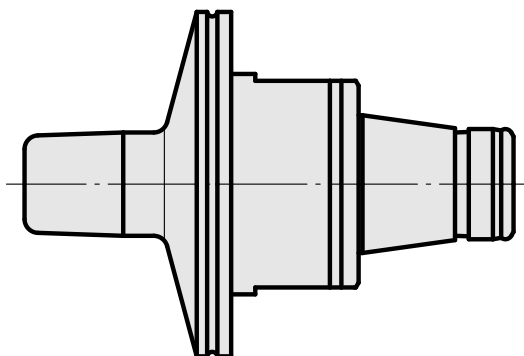
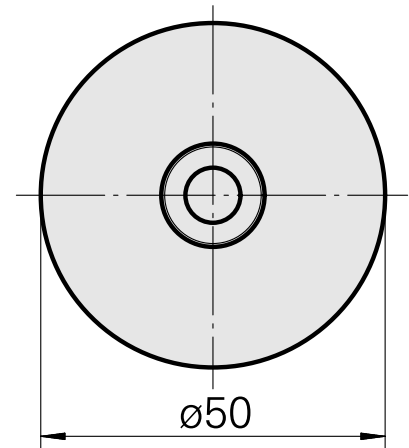
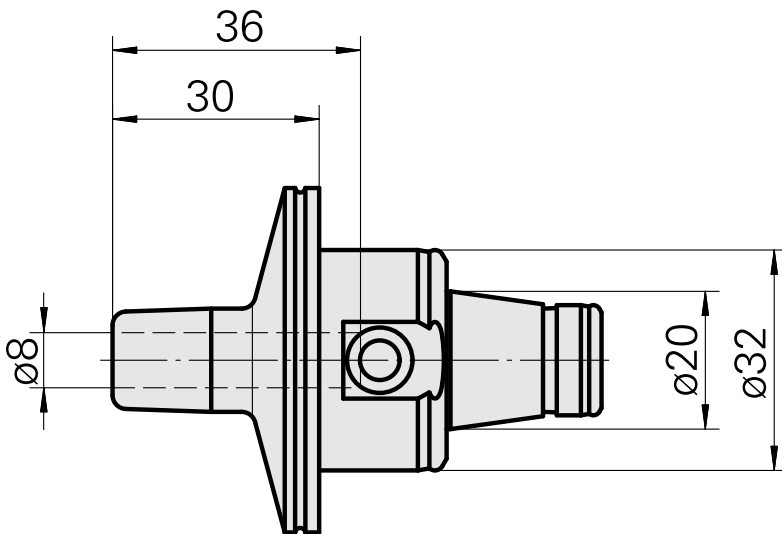
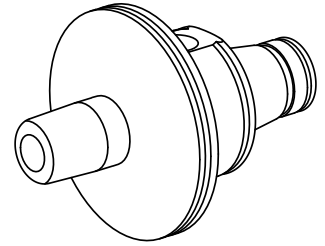

10915140  
836263

**INDEX**

---

## **Documents**

No downloads available for this product