

Saw blade, circular saw blade width 0.5 mm (0.019")

Technical data

TH accessories category

Circular saw blade d63

Tool mounting

16mm

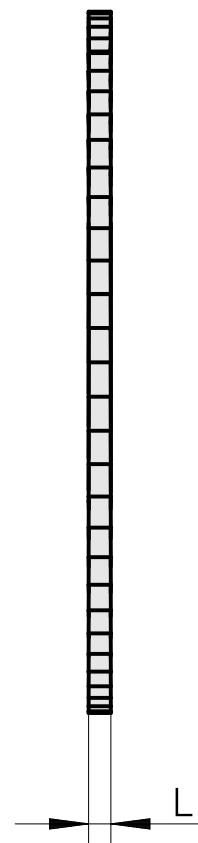
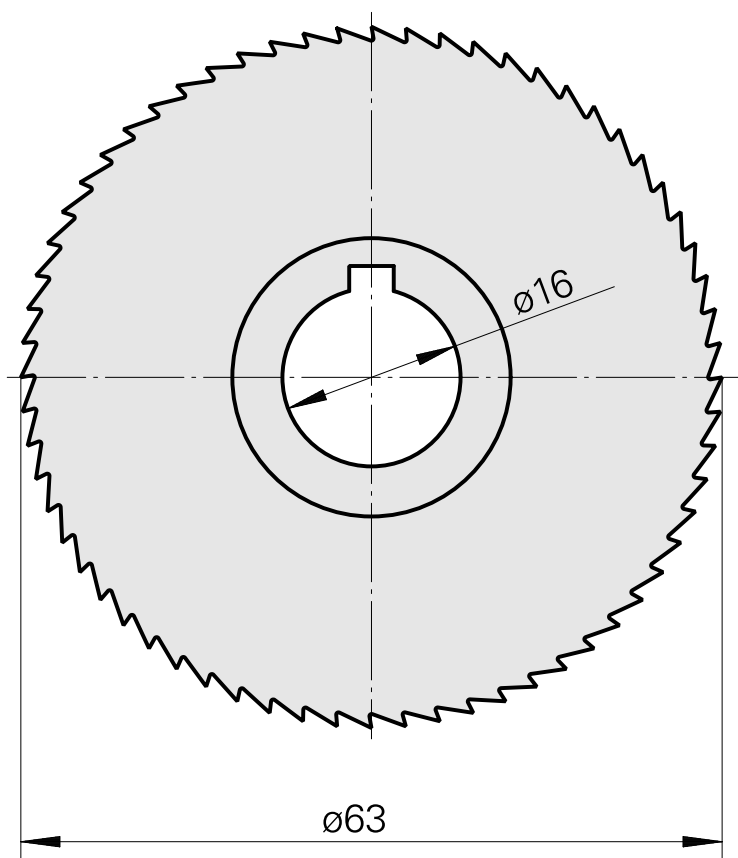

10899008
223010.6305

INDEX

Documents

No downloads available for this product