

## METALLKREISSÄGEBLATT, Breite Kreisägeblattes 0,6 mm

### Technische Daten

WZH Zubehörkategorie

Kreissägeblatt D63

Werkzeugaufnahme

16mm

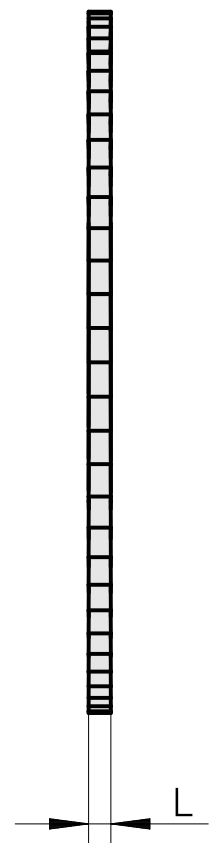
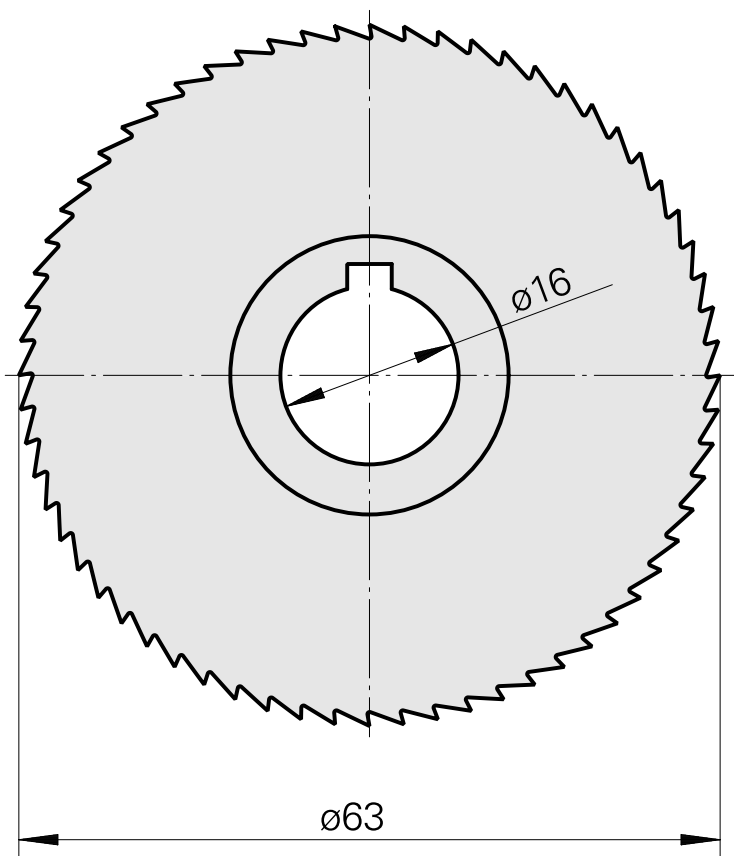
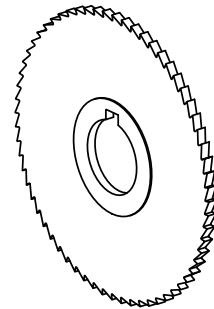

## **Dokumente**

Für dieses Produkt sind keine Downloads vorhanden