

## Bohrhalter D25

### Technische Daten

Antrieb	nicht angetrieben
Fixierung MS	Klemmring D36
Kühlung	innen
Druck	80 bar
Aufnahme	D25
X [mm]	-
Y [mm]	-
Z [mm]	-
Produkte INDEX TRAUB	MS32C • MS52C • MS32-6.2 • MS40-6 • MS40-8 • MS52-6.3 • MS32-6.3

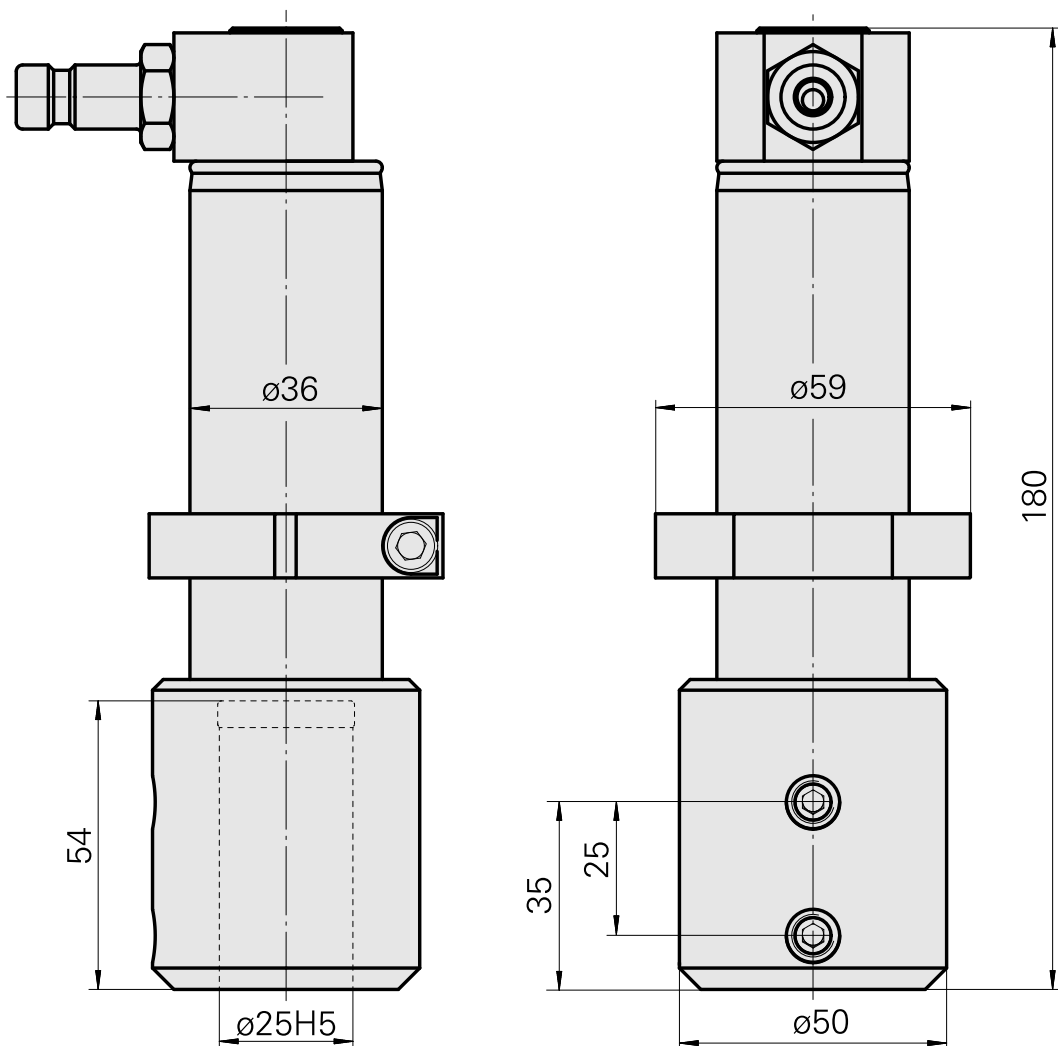
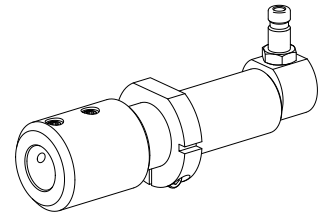

---

## Dokumente

Für dieses Produkt sind keine Downloads vorhanden

## Zubehör

Optionales Zubehör

**weiteres Zubehör**

### [Aufnahmebuchse mit Bund D25](#)

Artikel-Id : 10070544

frühere Artikel-Id : W62221.41--

---

### [Verschlusskupplung G1/4 SP-006-0-WR513-11-2 Serie LP](#)

Artikel-Id : 10837142

frühere Artikel-Id : 474940.0112

---

### [STECKNIPPEL G 1/4 SP-006-1-WR013-11 Serie LP](#)

Artikel-Id : 10186287

frühere Artikel-Id : 474946.25

---