

WFB 32-20 Montagem à ajust. à quente D10

Características técnicas

PF Categoria de acessórios

WFB 32-20

Recepção

Montagem à ajust. à quente D10

Inserções de troca rápida

consumo reduzido

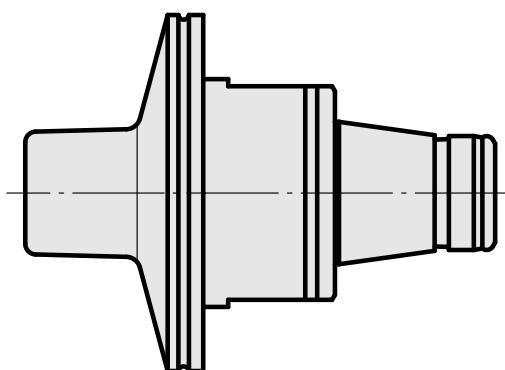
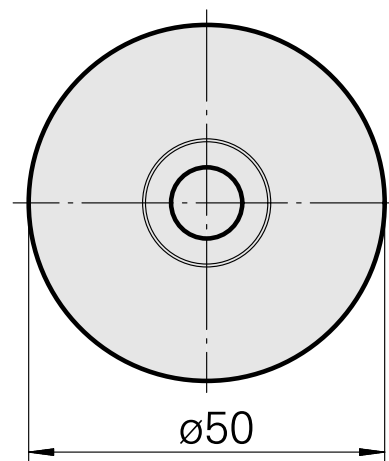
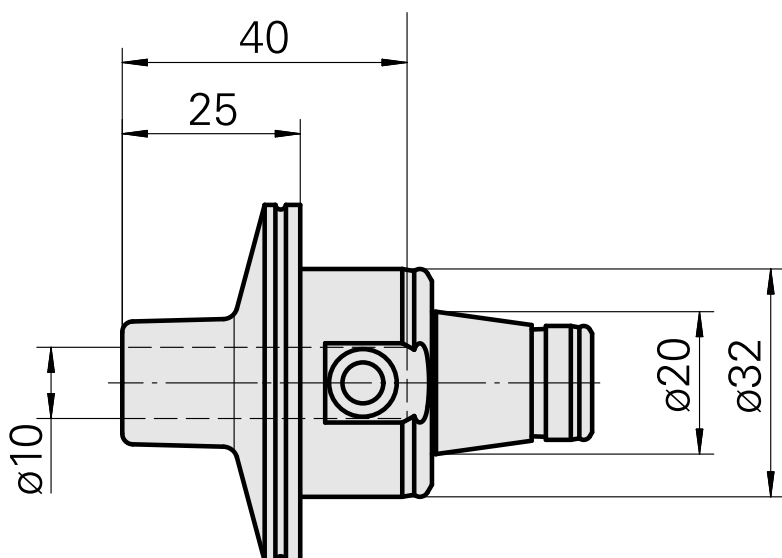
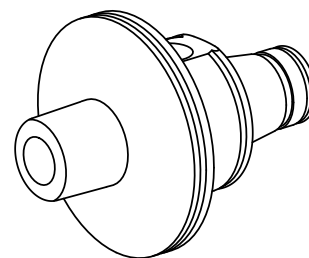

Documentos

Não há downloads disponíveis para este produto