

Zentrierspitze, 60° D28 mm für Hohlkörper

Technische Daten

WZH Zubehörkategorie

Zentrierspitze, universal

Aufnahme

D11,2/Kegel 1:7,5

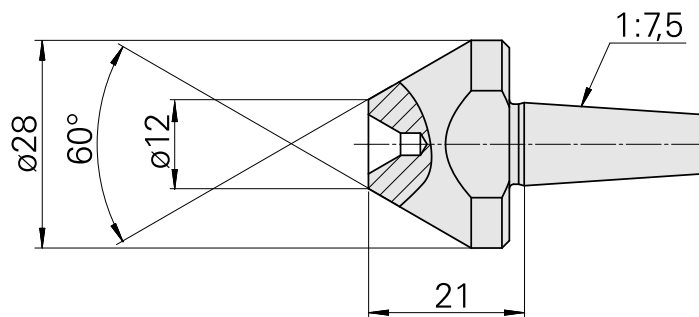
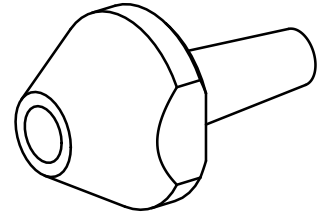

Dokumente

Für dieses Produkt sind keine Downloads vorhanden