

WFB 32-20 D4

Technical data

TH accessories category

WFB 32-20

Mounting

D4

Quick change inserts

Weldon mounting

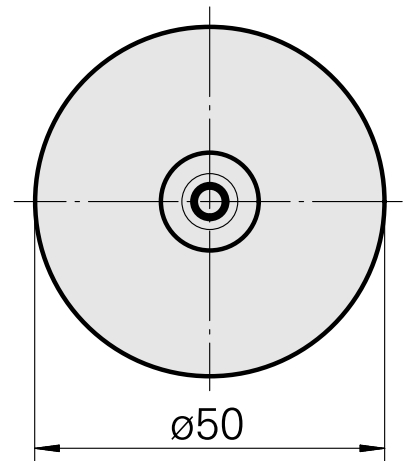
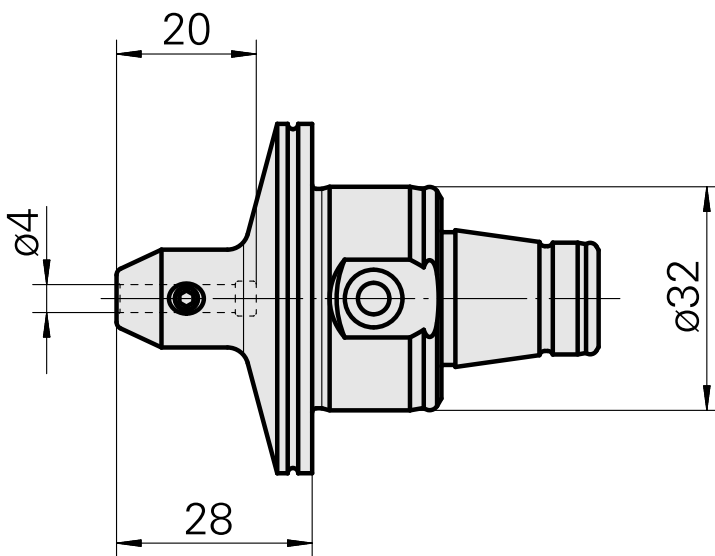

Documents

No downloads available for this product